

Project Num.

Date



General features

Description:

Insulation class: class II (class I on request)

Nominal voltage: 220-240 V 50/60 Hz

Protection level IP: IP66

Protection against impact: IK09

Surge Protection Device: Surge protection device: integrated 10kV-10kA, Type 3, equipped with LED signaling and thermofusible for disconnection at the end of life; impulse withstand CL II 10kV DM

Power factor: > 0.90

Ambient temperature Ta: -30°C +50°C

Weight: 4.20 kg

Maximum exposed surface: 0.06 m²

Lateral exposed surface: 0.030 m²

Common mode overvoltage protection: 10 kV

Differential mode overvoltage protection: 10 kV

Driver: included

Labels and Certifications: ENEC pending / CE

Warranty: 5 years for LED fittings

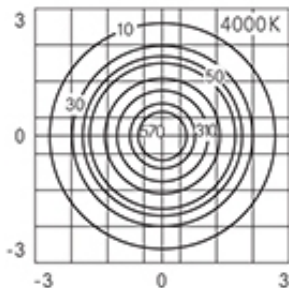
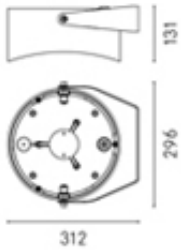

Performance Data

Power supply: 700 mA

Flux source: 3800 lm

Power source: 24 W

Efficiency of source: 158 lm/W

Flux fitting: 3270 lm

Power fitting: 27,5 W

Efficiency of fitting: 119 lm/W

Optical System

Source: LED R1

Colour temperature: 3000 K

Colour rendering index (CRI): ≥ 70 (Ra ≥ 80 on request)

Type of optics: rotosymmetrical LR-20

Optical unit lifetime: >160,000h @700mA @Ta25°C TM21 L80B20
>160,000h @700mA @Ta25°C TM21 L80B10

Photobiological safety class: EXEMPT GROUP

ULOR: 0 %

DLOR: 100 %

Normative framework

EN605981 / EN60598-2-3 / EN62471 / EN61547

Flux regulation

	Standard	On request
Self-learning virtual midnight	X	
Constant Light Output (CLO)		X
1-10V Regulation		X
Main voltage variation	X	
Pilot line		X
DALI Regulation	X	
Remote control system (PLC) telemanagement		X
Wireless telemanagement		X
Motion / brightness detectors		X

Installation and maintenance

Installation: pole / horizontal and vertical surfaces

Poles diameter: \varnothing 60 - 76 - 102 mm

Inclination: continuous / stepped adjustment -25° $+205^{\circ}$

\varnothing power cable: 10 ÷ 14 mm

Cable gland: PG16

Wiring plate substitutability: removable plate

Optical unit substitutability: LED disc replacement

Power supply compartment: independent from the optical system

Materials

Body: die-cast aluminium alloy UNI EN AB 46100

Screen: tempered flat glass

Lenses: PMMA high transparent

Fastening system: die-cast aluminium alloy UNI EN AB 46100

Seal: expanded anti-age silicone foam

Screws: stainless steel AISI 304

Wiring plate: zinc-plated steel

Finish: phospho-chromatation and painting with polyester powder

Colors

Sablé 100 Noir

Cod. **06KS5B20942CHM4**

Complements

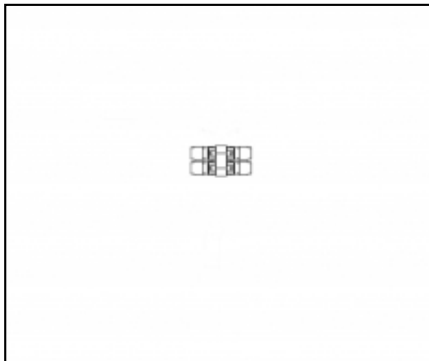

06KS909C0

B89 Connector 4 wai IP68

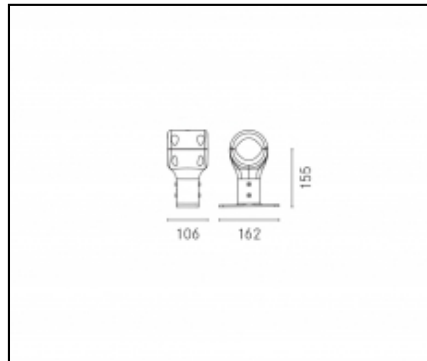

06KS916C0

B78 Attachment kit for bracket-pole mounting \varnothing 60-76 mm. Colour: Sablé 100 Noir.

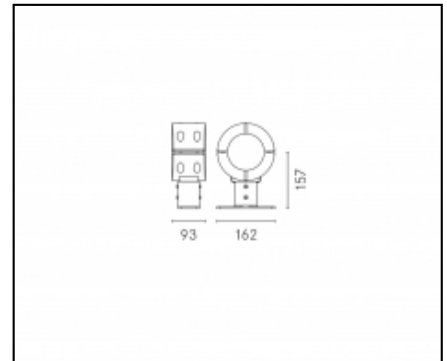

06KS917C0

B97 Attachment kit for bracket-pole mounting \varnothing 102 mm. Colour: Sablé 100 Noir.

NOTE

The features of the product listed above are subjected to change without notice. They will have to be confirmed in case of order.
Values indicated in this technical sheet are to be considered nominal values.
In order to facilitate a constant updating of their products, Cariboni Group reserves the right to make changes without prior notice.