

Project Num.

Date



General features

Description:

Insulation class: class II (class I on request)

Nominal voltage: 220-240 V 50/60 Hz

Protection level IP: IP66

Protection against impact: IK09

Surge Protection Device: Surge protection device: integrated 10kV-10kA, Type 3, equipped with LED signaling and thermofusible for disconnection at the end of life; impulse withstand CL II 10kV DM

Power factor: > 0.90

Ambient temperature Ta: -30°C +50°C

Weight: 9.20 kg

Maximum exposed surface: 0.140 m²

Lateral exposed surface: 0.063 m²

Common mode overvoltage protection: 10 kV

Differential mode overvoltage protection: 10 kV

Driver: included

Labels and Certifications: ENEC pending / CE

Warranty: 5 years for LED fittings

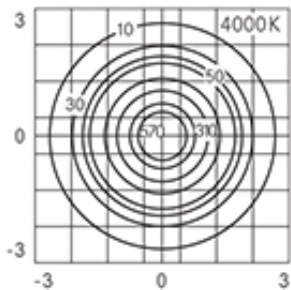

Performance Data

Power supply: 350 mA

Flux source: 2150 lm

Power source: 11,5 W

Efficiency of source: 187 lm/W

Flux fitting: 1845 lm

Power fitting: 14,5 W

Efficiency of fitting: 127 lm/W

Optical System
Source: LED R1
Colour temperature: 3000 K
Colour rendering index (CRI): ≥ 70 (Ra ≥ 80 on request)
Type of optics: rotosymmetrical LR-20
Optical unit lifetime: >160,000h @700mA @Ta25°C TM21 L80B20 >160,000h @700mA @Ta25°C TM21 L80B10
Photobiological safety class: EXEMPT GROUP
ULOR: 0 %
DLOR: 100 %
Normative framework
EN605981 / EN60598-2-3 / EN62471 / EN61547

Flux regulation	Standard	On request
Self-learning virtual midnight	X	
Constant Light Output (CLO)		X
1-10V Regulation		X
Main voltage variation	X	
Pilot line		X
DALI Regulation	X	
Remote control system (PLC) telemanagement		X
Wireless telemanagement		X
Motion / brightness detectors		X

Installation and maintenance
Installation: pole / horizontal and vertical surfaces
Poles diameter: \varnothing 60 - 76 - 102 mm
Inclination: continuous / stepped adjustment -25° $+205^{\circ}$
\varnothing power cable: 10 ÷ 14 mm
Cable gland: PG16
Wiring plate substitutability: removable plate
Optical unit substitutability: LED disc replacement
Power supply compartment: independent from the optical system

Materials	
Body: die-cast aluminium alloy UNI EN AB 46100	
Screen: tempered flat glass	
Lenses: PMMA high transparent	
Fastening system: die-cast aluminium alloy UNI EN AB 46100	
Seal: expanded anti-age silicone foam	
Screws: stainless steel AISI 304	
Wiring plate: zinc-plated steel	
Finish: phospho-chromatation and painting with polyester powder	
Colors	
Sablé 100 Noir	Cod. 06KS6B23942CHM4

Complements

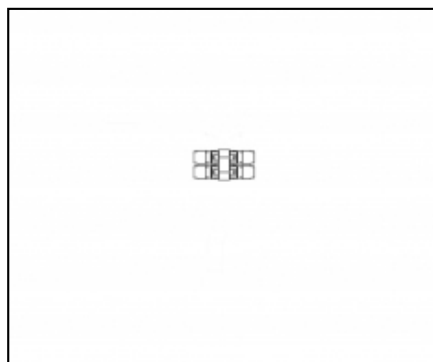

06KS909C0

B89 Connector 4 wai IP68

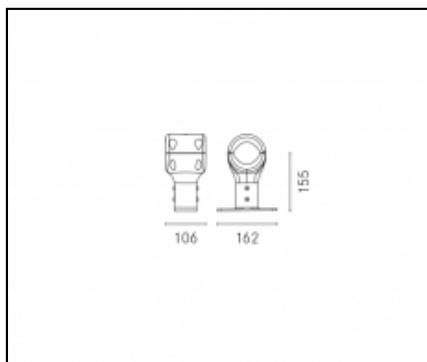

06KS916C0

B78 Attachment kit for bracket-pole mounting \varnothing 60-76 mm. Colour: Sablé 100 Noir.

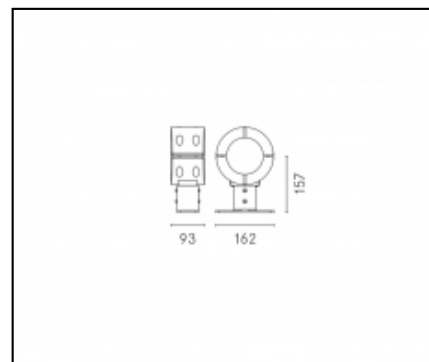

06KS917C0

B97 Attachment kit for bracket-pole mounting \varnothing 102 mm. Colour: Sablé 100 Noir.

NOTE

The features of the product listed above are subjected to change without notice. They will have to be confirmed in case of order.
Values indicated in this technical sheet are to be considered nominal values.
In order to facilitate a constant updating of their products, Cariboni Group reserves the right to make changes without prior notice.