

Product Sheet**Sigma Street**

Options: medium
 Colour temperature: 4000 K
 Type of optics: asymmetrical LT-06

06SG4E80037CHM4

Colour: Sablé 100 Noir

Project Num.

Date

**General features**

Description: LED fitting for lighting façades, streets, walkways and urban spaces

Insulation class: class II (class I on request)

Nominal voltage: 220-240 V 50/60 Hz

Protection level IP: IP66

Protection against impact: IK09

Surge Protection Device: Surge protection device: integrated 10kV-10kA, Type 3, equipped with LED signaling and thermofusible for disconnection at the end of life; impulse withstand CL II 10kV DM

Power factor: > 0.90

Ambient temperature Ta: -30°C +50°C

Weight: 8.00 kg

Maximum exposed surface: 0.13 m²

Lateral exposed surface: 0,075 m²

Common mode overvoltage protection: 10 kV

Differential mode overvoltage protection: 10 kV

Driver: included

Labels and Certifications: ENEC pending / CE

Warranty: 5 years for LED fittings

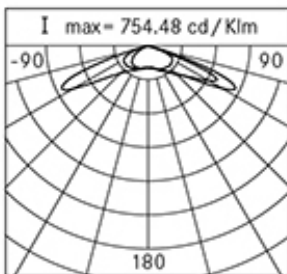
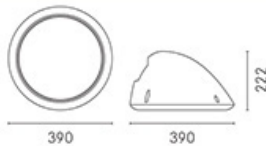
**Performance Data***

Power supply:	700 mA
Flux source:	16390 lm
Power source:	95,5 W
Efficiency of source:	172 lm/W
Flux fitting:	13440 lm
Power fitting:	104 W
Efficiency of fitting:	129 lm/W
Dazzling index category:	D5

Optical System

Source: LED R4

Colour temperature: 4000 K

Colour rendering index (CRI): ≥ 70 (Ra ≥ 80 on request)

Type of optics: asymmetrical LT-06

Optical unit lifetime: >160,000h @700mA @Ta25°C TM21 L80B20
>160,000h @700mA @Ta25°C TM21 L80B10

Photobiological safety class: EXEMPT GROUP

ULOR: 0 %

DLOR: 100%

Luminous intensity category: G*6

Normative framework

EN605981 / EN60598-2-3 / EN62471 / EN61547

Installation and maintenance

Installation: post top / side pole / arm / wall

Poles diameter: \varnothing 60 - 76 - 102 mm

Inclination: -90° $+35^{\circ}$, continuously-adjustable pointing and locking system.

Fastening: the product can be equipped with a fixing base for wall mounting, an adjustable joint for installation on arm and pole or with the new post top accessory.

Wiring: the product is supplied with an outgoing cable (L = 0,2m) and a 4-pin plug and socket connector for a quick and easy installation.

\varnothing power cable: 10 + 14 mm

Cable gland: PG16

Wiring plate substitutability: removable plate

Optical unit substitutability: each LED module is replaceable

Opening screen: opening by means of tools

Power supply compartment: independent from the optical group

Flux regulation

	Standard	On request
Self-learning virtual midnight	X	
Constant Light Output (CLO)		X
1-10V Regulation		X
Main voltage variation		X
Pilot line		X
DALI Regulation	X	
Remote control system (PLC) telemanagement		X
Wireless telemanagement		X
Motion / brightness detectors		X

Materials

Body: die-cast aluminium alloy UNI EN AB 47100 (copper content < 1%)

Screen: tempered flat glass

Lenses: PMMA high transparent

Fastening system: die-cast aluminium alloy UNI EN AB 47100 (copper content < 1%)

Seal: expanded anti-age silicone foam

Screws: stainless steel AISI 304

Wiring plate: zinc-plated steel

Finish: phospho-chromatation and painting with polyester powder

Colors

Sablé 100 Noir

Cod. **06SG4E80037CHM4**

Complements

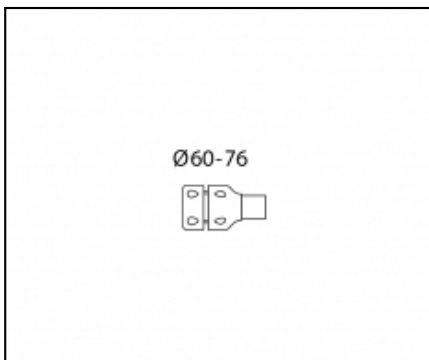

01AK903C0

L3 joint kit for Ø60-76mm pole or arm.
Colour: dark grey sablé 100 noir.

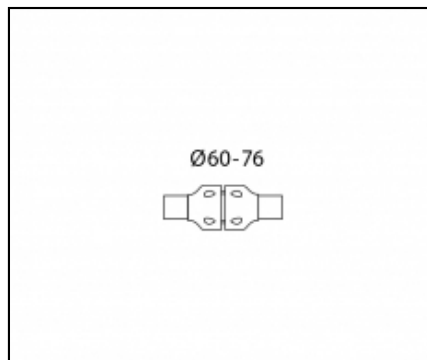

01AK904C0

L4 double joint kit for Ø60-76mm pole or arm.
Colour: dark grey sablé 100 noir.

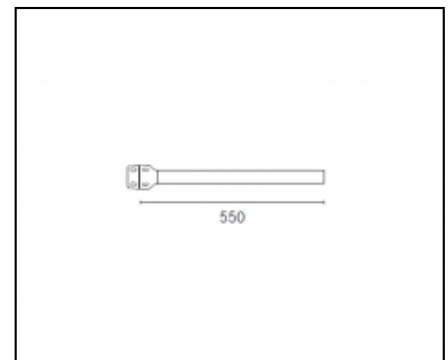

01AK921C0

B1 Arm tubular Ø 60 mm. L=550 mm for Ø 60-76 mm poles.
Colour: Sablé 100 Noir.

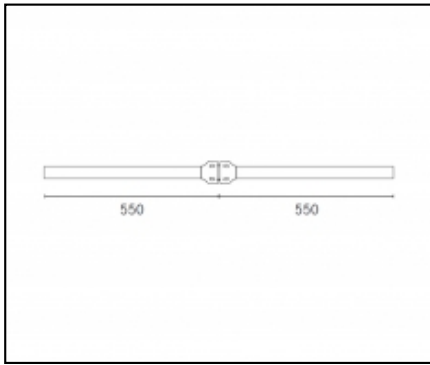

01AK922C0

B2 Double arm tubular Ø 60 mm. L=550 mm for Ø 60-76 mm poles. Colour: Sablé 100 Noir.

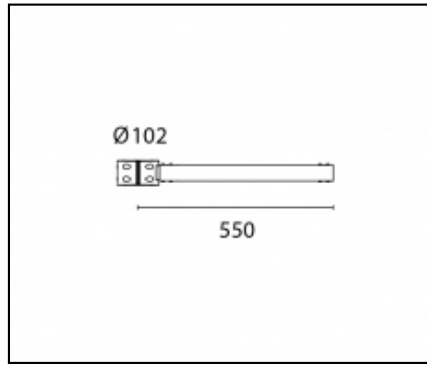

06AK907C0

B155 Single arm L550mm pole Ø102mm

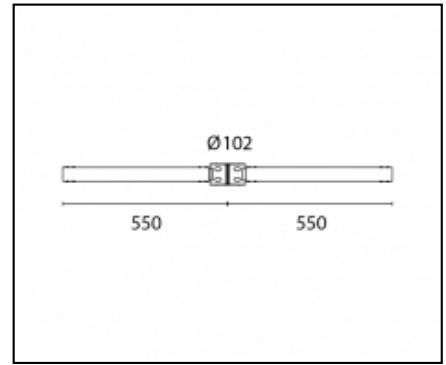

06AK909C0

B157 Double arm L550mm pole Ø102mm

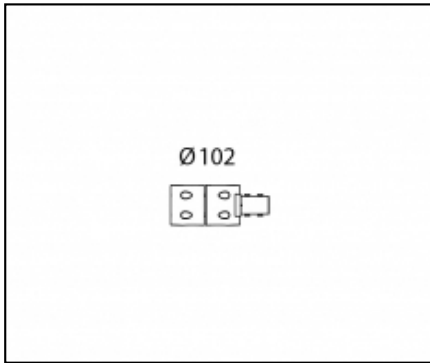

06AK916C0

B139 Single ring Ø102mm

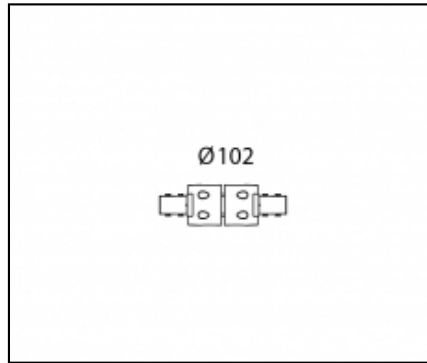

06AK917C0

B140 Double ring for pole Ø102mm

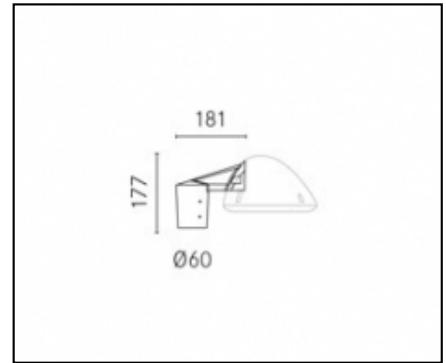

06SG905C0

B178 Kit post top Ø60mm H 90mm Sablé

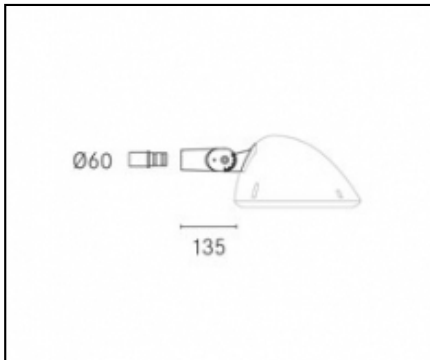

06SG907C0

B180 Kit pole side Ø60-76mm Sablé

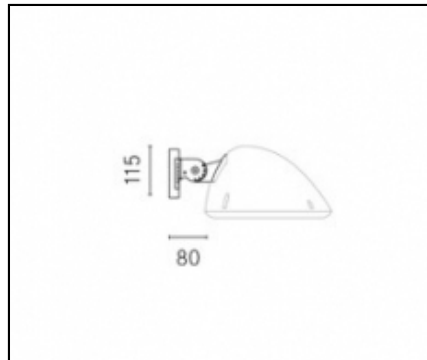

06SG909C0

B182 Adjustable joint for wall or ground Sablé

NOTE

***Performance Data**

Values indicated in this technical sheet are to be considered nominal values with a tolerance of +/-7%.

Data of the lighting source flux and efficiency refer to the LED module, without lenses. In case you need data of the LED module complete with lenses, please multiply the mentioned data by 0.9 factor.

General Data

The features of the product listed above may be subjected to change without notice. They will have to be confirmed in case of order. In order to facilitate a constant updating of their products, Cariboni Group reserves the right to make changes without prior notice.