

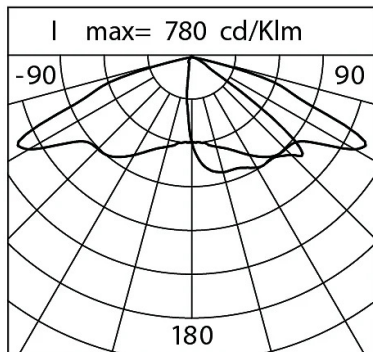

General Features

- Description: LED fitting for lighting façades, paths and urban spaces
- Insulation class: class II
- Rated voltage: 220-240 V 50/60 Hz
- Protection Grade: IP66
- Impact protection: IK09
- Power Factor: > 0.9
- Ambient temperature Ta: -25° C + 50° C
- Max exposed surface: 0.152 m²
- Lateral exposed surface: 0.07 m²
- Common mode surge protection: 10 kV
- Overvoltage protection differential mode: 10 kV
- Driver: included
- Driver lifetime: > 100.000 h @Ta 25° C
- Marks and Certifications: CE / ENEC

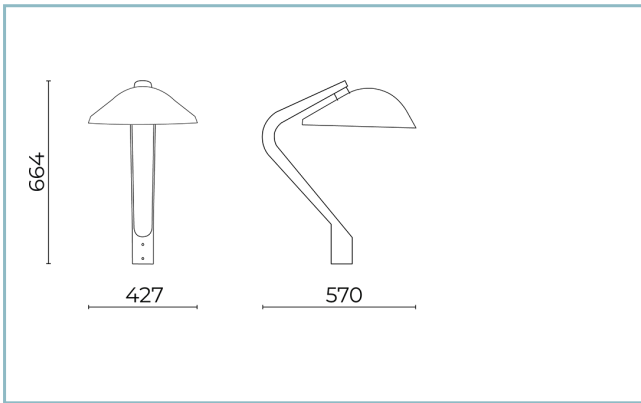

Performance Data*	1800	2200	2700	3000
LED Current:	530 mA	530 mA	530 mA	530 mA
Source flux:	2820 lm	3470 lm	3985 lm	4050 lm
Source power:	25.6 W	25.6 W	25.6 W	25.6 W
Source efficiency:	110 lm/W	136 lm/W	156 lm/W	158 lm/W
Device flux:	2425 lm	2985 lm	3425 lm	3485 lm
Device power:	30.5 W	30.5 W	30.5 W	30.5 W
Appliance efficiency:	80 lm/W	98 lm/W	112 lm/W	114 lm/W
Glare Index Category:	D6	D6	D6	D6

Product Sheet

Rev 13.02.25

Spoon Post Top

Size: large

Color Temperature: DWL 1800 K - 3000 K

Type of optics: LA-03 Wide street

06SP0Q4000317G6DWL

Colour: Champagne

Optical System

Source: LED R1

Color Temperature: DWL 1800 K - 3000 K

Color Rendering Index (CRI): 70

Chromatic consistency (SDCM): ≤ 3

Type of optics: LA-03 Wide street

Optical group life: > 100.000 h @ 720mA @ Ta 25° C TM21 L90B10

Photobiological safety class: EXEMPT GROUP

ULOR: 0%

DLOR: 100%

Light intensity category: G*3

Normative References

EN60598-1 :2021 + A11 :2022 / EN60598-2-3 :2003 + A1+2011 / IEC/TR62778 / EN62471 / EN61547

Installation and maintenance

Wiring: The product comes with an outgoing cable (L = 200 mm) and plug-socket connector (2P) for quick and easy installation.

Ø power cable: 6 ÷ 11 mm

Cable Gland: PG13,5

Power supply compartment: independent from the optical group

Materials

Body: die-cast aluminium alloy UNI EN AB 47100 (copper content < 1%)

Screen: tempered flat glass

Lenses: high-transparency PMMA

Fixing system:

Seals:

Screws:

Wiring plate:

Finish:

Colors Champagne

Code:

06SP0Q4000317G6DWL

Product Sheet

Rev 13.02.25

Spoon Post Top

Size: large

Color Temperature: DWL 1800 K - 3000 K

Type of optics: LA-03 Wide street

06SP0Q4000317G6DWLColour: Champagne

NOTES***Performance data**

The values indicated in this data sheet are nominal values with a tolerance of +/-7%.

Source flux and source efficiency data refer to the LED module without optics; in case you are interested in the performance of the LED module complete with optical system, you must multiply the data reported by the factor 0.9.

General Data

The characteristics of the product listed may be subject to change and must be confirmed when ordering.

In order to promote constant updating of its products, Cariboni Group reserves the right to make changes without prior notice.