



General Features

Description: LED fitting for lighting façades, paths and urban spaces

Insulation class: class II

Rated voltage: 220-240 V 50/60 Hz

Protection Grade: IP66

Impact protection: IK09

Power Factor: > 0.9

Ambient temperature Ta: -25° C + 50° C

Max exposed surface: 0.212 m²

Lateral exposed surface: 0.087 m²

Common mode surge protection: 10 kV

Overtoltage protection differential mode: 10 kV

Driver: included

Driver lifetime: > 100.000 h @Ta 25° C

Marks and Certifications: CE / ENEC

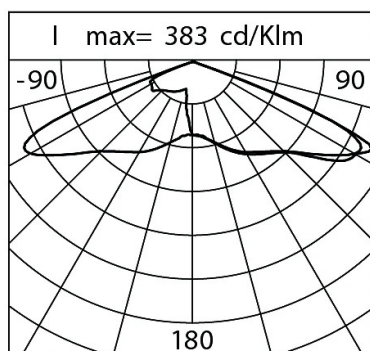
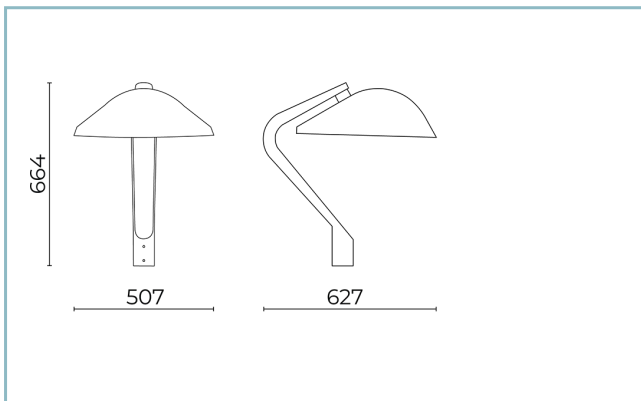

Performance Data*	3000
LED Current:	300 mA
Source flux:	7650 lm
Source power:	39 W
Source efficiency:	196 lm/W
Device flux:	5395 lm
Device power:	45 W
Appliance efficiency:	120 lm/W
Glare Index Category:	D6

Product Sheet

Rev 13.02.25

Spoon Post Top

Size: x-large

Color Temperature: 3000 K

Type of optics: RS-02 Rotosymmetric Beam

06SP0R9001024G6HL

Colour: Champagne

Optical System

Source: LED R3

Color Temperature: 3000 K

Color Rendering Index (CRI): 80

Chromatic consistency (SDCM): ≤ 3

Type of optics: RS-02 Rotosymmetric Beam

Optical group life: > 100.000 h @ 720mA @ Ta 25° C TM21 L90B10

Photobiological safety class: EXEMPT GROUP

ULOR: 0%

DLOR: 100%

Light intensity category: G*3

Normative References

EN60598-1 :2021 + A11 :2022 / EN60598-2-3 :2003 + A1+2011 / IEC/TR62778 / EN62471 / EN61547

Installation and maintenance

Wiring: The product comes with an outgoing cable (L = 200 mm) and plug-socket connector (2P) for quick and easy installation.

Ø power cable: 6 ÷ 11 mm

Cable Gland: PG13,5

Power supply compartment: independent from the optical group

Materials

Body: die-cast aluminium alloy UNI EN AB 47100 (copper content < 1%)

Screen: tempered flat glass

Lenses: high-transparency PMMA

Fixing system:

Seals:

Screws:

Wiring plate:

Finish:

Colors

■ Champagne

Code: **06SP0R9001024G6HL**

Product Sheet

Rev 13.02.25

Spoon Post Top

Size: x-large

Color Temperature: 3000 K

Type of optics: RS-02 Rotosymmetric Beam

06SP0R9001024G6HLColour: Champagne

NOTES***Performance data**

The values indicated in this data sheet are nominal values with a tolerance of +/-7%.

Source flux and source efficiency data refer to the LED module without optics; in case you are interested in the performance of the LED module complete with optical system, you must multiply the data reported by the factor 0.9.

General Data

The characteristics of the product listed may be subject to change and must be confirmed when ordering.

In order to promote constant updating of its products, Cariboni Group reserves the right to make changes without prior notice.