



### General Features

Description: lantern designed to house the LED technology

Insulation class: class II

Rated voltage: 220-240 V 50 Hz

Protection Grade: IP66

Impact protection: IK08

Surge protection device: integrated 10kV-10kA, Type 3, equipped with LED signaling and thermofusible for disconnection at the end of life; impulse withstand CL II 10kV DM

Power Factor: > 0.90

Ambient temperature Ta: -30°C +50°C

Weight: 8.00 kg

Max exposed surface: 0,19 m<sup>2</sup>

Lateral exposed surface: 0,09 m<sup>2</sup>

Common mode surge protection: 10 kV

Overvoltage protection differential mode: 10 kV

Driver: included

Driver lifetime: >100.000 h @ Ta 25°C (0,2% / 1000h)

Marks and Certifications: ENEC / CE

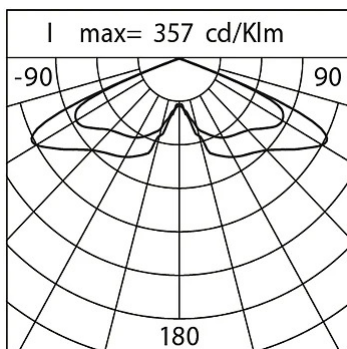

### Performance Data\*

Source flux:	7660 lm
Source power:	49 W
Source efficiency:	156 lm/W
Device flux:	6050 lm
Device power:	53 W
Appliance efficiency:	114 lm/W
Glare Index Category:	D6

### Optical System

Source: LED R2
Color Temperature: 2200 K
Color Rendering Index (CRI): $\geq 70$
Chromatic consistency (SDCM): $\leq 3$
Type of optics: RS-02 Rotosymmetric Beam
Optical group life: $>100.000$ h @ Ta 25°C L90B10
Photobiological safety class: EXEMPT GROUP
ULOR: 0%
DLOR: 100%
Light intensity category: G*6

### Normative References

EN60598-1 / EN60598-2-3 / EN62471 / EN61547
---

### Installation and maintenance

Installation: arcade
Fixing: arm or chain suspended - standard on arms with a 3/4" female gas attachment; on $\varnothing 60$ mm arms using the required accessory (code 01AG902C0); fastening system (code 01AG903C0) for catenary suspension system.
$\varnothing$ power cable: 10 ÷ 14 mm
Cable Gland: PG16
Replaceable wiring plate: removable plate
Replaceable optical unit: each LED module is replaceable
Disconnecter: automatic (with terminal section 2.5 mm <sup>2</sup> )
Power supply compartment: independent from the optical system

### Flow adjustment

	On request
Virtual Midnight Teaching	X
Constant flow output (CLO)	X
DALI control	X
Power line telemanagement (PLC)	X
Wireless remote management	X

### Materials

Body: die-cast aluminium alloy UNI EN AB 47100 (copper content $< 1\%$ )
Screen: extra clear tempered flat glass 4 mm
Lenses: high-transparency PMMA
Fixing system: die-cast aluminium alloy UNI EN AB 47100 (copper content $< 1\%$ )
Seals: expanded anti-age silicone foam
Screws: stainless steel AISI 304
Wiring plate: zinc-plated steel
Finish: phospho-chromatation treated and polyester powder-coated in 16 phases to increase weather resistance

### Colors

■ Sablé 100 Noir	Code: <b>01AG3C454124CHM4</b>
------------------	-------------------------------

---

### Mandatory accessories

---



01AG903C0

Hook for chain suspension

---

### Optional accessories

---



01AG902C0

Fastening adapter 3/4" gas  
for arms UP & DOWN Ø 60 mm.

---

### NOTES

#### \*Performance data

The values indicated in this data sheet are nominal values with a tolerance of +/-7%.

Source flux and source efficiency data refer to the LED module without optics; in case you are interested in the performance of the LED module complete with optical system, you must multiply the data reported by the factor 0.9.

#### General Data

The characteristics of the product listed may be subject to change and must be confirmed when ordering.

In order to promote constant updating of its products, Cariboni Group reserves the right to make changes without prior notice.