



### General Features

Description: lantern designed to house the LED technology

Insulation class: class II

Rated voltage: 220-240 V 50 Hz

Protection Grade: IP66

Impact protection: IK08

Surge protection device: integrated 10kV-10kA, Type 3, equipped with LED signaling and thermofusible for disconnection at the end of life; impulse withstand CL II 10kV DM

Power Factor: > 0.90

Ambient temperature Ta: -30°C +50°C

Weight: 8.00 kg

Max exposed surface: 0,19 m<sup>2</sup>

Lateral exposed surface: 0,09 m<sup>2</sup>

Common mode surge protection: 10 kV

Overvoltage protection differential mode: 10 kV

Driver: included

Driver lifetime: >100.000 h @ Ta 25°C (0,2% / 1000h)

Marks and Certifications: ENEC / CE

### Performance Data\*

Source flux:	2040 lm
Source power:	9 W
Source efficiency:	226 lm/W
Device flux:	1630 lm
Device power:	12 W
Appliance efficiency:	135 lm/W
Glare Index Category:	D6

### Optical System

Source: LED R1
Color Temperature: 4000 K
Color Rendering Index (CRI): $\geq 70$
Chromatic consistency (SDCM): $\leq 3$
Type of optics: ST-02 Narrow street
Optical group life: $>100.000$ h @ Ta 25°C L90B10
Photobiological safety class: EXEMPT GROUP
ULOR: 0%
DLOR: 100%
Light intensity category: G*3

### Normative References

EN60598-1 / EN60598-2-3 / EN62471 / EN61547

### Installation and maintenance

Installation: post top
Pole diameter: 3/4
Fixing: post top - standard with 3/4" male gas attachment; on $\varnothing 60$ mm poles using the required accessory (code 01AG901C0); on poles with a 3/4" female gas attachment using the required accessory (code 01AG900C0); arm mounted - standard with 3/4" male gas attachment; on arms with a 3/4" female gas attachment using the required accessory (code 01AG900C0); on $\varnothing 60$ mm arms using the required accessory (code 01AG902C0).
$\varnothing$ power cable: 10 ÷ 14 mm
Cable Gland: PG16
Replaceable wiring plate: removable plate
Replaceable optical unit: each LED module is replaceable
Disconnecter: automatic (with terminal section 2.5 mm <sup>2</sup> )
Power supply compartment: independent from the optical system

### Flow adjustment

On request

Virtual Midnight Teaching	X
Constant flow output (CLO)	X
DALI control	X
Power line telemanagement (PLC)	X
Wireless remote management	X

### Materials

Body: die-cast aluminium alloy UNI EN AB 47100 (copper content $< 1\%$ )
Screen: extra clear tempered flat glass 4 mm
Lenses: high-transparency PMMA
Fixing system: die-cast aluminium alloy UNI EN AB 47100 (copper content $< 1\%$ )
Seals: expanded anti-age silicone foam
Screws: stainless steel AISI 304
Wiring plate: zinc-plated steel
Finish: phospho-chromatation treated and polyester powder-coated in 16 phases to increase weather resistance

### Colors

■ Sablé 100 Noir	Code: <b>01AG1B221014CHM4</b>
------------------	-------------------------------

### Mandatory accessories



01AG901C0

Fastening kit post top  
Ø 60 mm H 90 mm. Colour: Sablé 100  
Noir.

### Optional accessories



01AG902C0

Fastening adapter 3/4" gas  
for arms UP & DOWN Ø 60 mm.



01AG900C0

Fastening kit on poles / arms UP  
with female 3/4" gas.



01AK970C0

Collar for pole  
Ø 102/76 mm. Colour: Sablé 100 Noir.



01AK971C0

Collar for pole  
Ø 127/76 mm. Colour: Sablé 100 Noir.



01AK972C0

Low base  
for poles Ø 102 mm. Colour: Sablé 100  
Noir.



01AK973C0

High base  
for poles Ø 102/76 mm. Colour: Sablé  
100 Noir.



01AK974C0

High base  
for poles Ø 127mm. Colour: Sablé 100  
Noir.

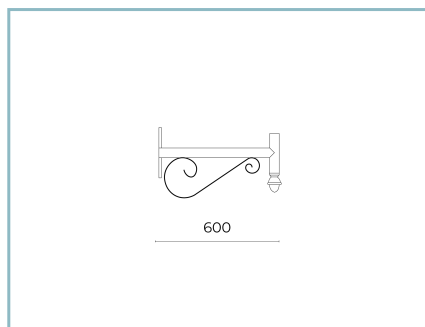

01AG924C0

B64-P Wall-mounted arm  
UP L=600 mm. Colour: Sablé 100 Noir.



01AG925C0

B65-P Wall-mounted arm  
UP L=1000 mm. Colour: Sablé 100 Noir.



01AG914C0

B64 Single arm UP  
for tapered poles Ø 127/76 mm. L=600  
mm. Colour: Sablé 100 Noir.



01AG918C0

B68 Double arm UP  
for tapered poles Ø 127/76 mm. L=600  
mm. Colour: Sablé 100 Noir.



01AG915C0

B65 Single arm UP  
for tapered poles Ø 127/76 mm. L=1000  
mm. Colour: Sablé 100 Noir.



01AG919C0

B69 Double arm UP  
for tapered poles Ø 127/76 mm. L=1000  
mm. Colour: Sablé 100 Noir.



01AG910C0

B60 Single curved arm UP  
for cylindrical poles Ø 102 mm. L=810  
mm. Colour: Sablé 100 Noir.



01AG911C0

B61 Double curved arm UP  
for cylindrical poles Ø 102 mm. L=810  
mm. Colour: Sablé 100 Noir.



01AG922C0

B60-P Curved wall-mounted arm  
UP L=810 mm. Colour: Sablé 100 Noir.

#### NOTES

##### \*Performance data

The values indicated in this data sheet are nominal values with a tolerance of +/-7%.

Source flux and source efficiency data refer to the LED module without optics; in case you are interested in the performance of the LED module complete with optical system, you must multiply the data reported by the factor 0.9.

##### General Data

The characteristics of the product listed may be subject to change and must be confirmed when ordering.

In order to promote constant updating of its products, Cariboni Group reserves the right to make changes without prior notice.