

General Features

Description:	Recessed product
Insulation class:	class III
Rated voltage:	24 Vdc
Protection Grade:	IP66
Impact protection:	IK08
Power Factor:	> 0.9
Ambient temperature Ta:	-30°C +50°C
Weight:	1.00 kg
Driver:	remote (to be ordered separately)
Marks and Certifications:	CE

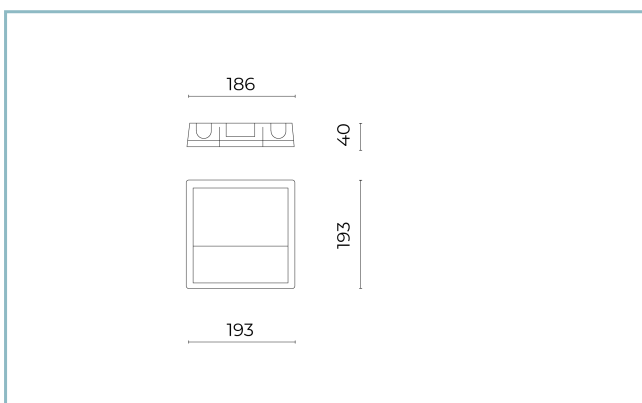

Performance Data*

LED Current:	500 mA
Source flux:	815 lm
Source power:	6.5 W
Source efficiency:	125 lm/W
Device flux:	250 lm
Device power:	7.5 W
Appliance efficiency:	33 lm/W
Glare Index Category:	D6

Optical System

Source: 8 LED

Color Temperature: 2200 K

Color Rendering Index (CRI): ≥ 80

Chromatic consistency (SDCM): ≤ 3

Type of optics: AS-D

Optical group life: >60.000h @Ta25°C L80B10

Photobiological safety class: EXEMPT GROUP

Normative References

EN60598-1 / EN60598-2-3 / EN62471 / EN61547

Installation and maintenance

Installation: wall recessed

Wiring: rear cable entry, pre-wiring with outgoing cable

Flow adjustment

Standard

DALI control

X

Materials

Body: die-cast aluminium alloy UNI EN AB 47100 (copper content < 1%)

Screen: polycarbonate

Optical Collimator: nylon PA66

Finish: phospho-chromatation treated and polyester powder-coated in 16 phases to increase weather resistance

Colors

■ Sablé 100 Noir

Code: **06APIA84147CV**

Mandatory accessories

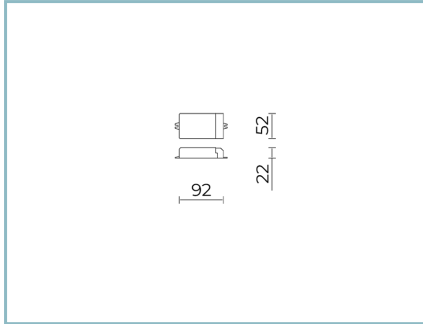

06LX900X0

B176 DALI driver 16W IP20

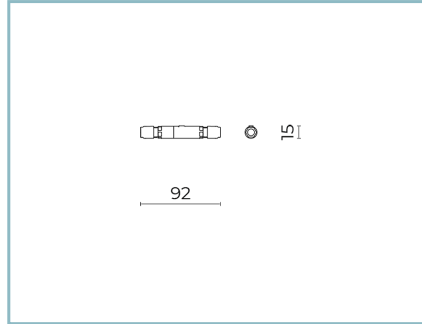

06AP901X0

M1 CONNECTOR
IP68 2P CL.III - DALI

NOTES

*Performance data

The values indicated in this data sheet are nominal values with a tolerance of +/-7%.

Source flux and source efficiency data refer to the LED module without optics; in case you are interested in the performance of the LED module complete with optical system, you must multiply the data reported by the factor 0.9.

General Data

The characteristics of the product listed may be subject to change and must be confirmed when ordering.

In order to promote constant updating of its products, Cariboni Group reserves the right to make changes without prior notice.