

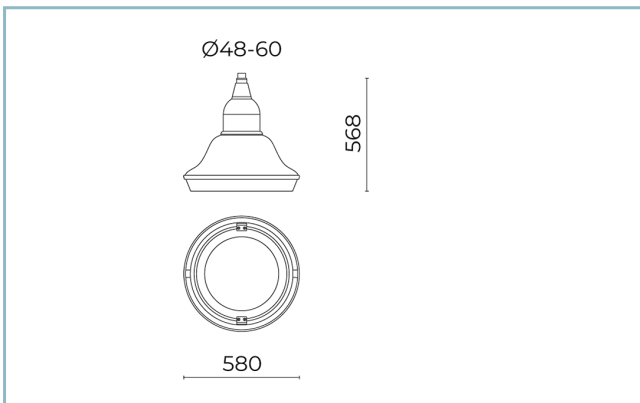

General Features

Description: urban and public lighting luminaire
Insulation class: class II
Rated voltage: 220-240 V 50/60 Hz
Protection Grade: IP66
Impact protection: IK08
Surge protection device: integrated 10kV-10kA, Type 3, equipped with LED signaling and thermofusible for disconnection at the end of life; impulse withstand CL II 10kV DM
Power Factor: > 0.9
Ambient temperature Ta: -30°C +50°C
Weight: 11.00 kg
Max exposed surface: 0,25 m ²
Lateral exposed surface: 0,14 m ²
Common mode surge protection: 10 kV
Overtoltage protection differential mode: 10 kV
Driver: included
Marks and Certifications: ENEC / CE



Performance Data*

LED Current:	700 mA
Source flux:	7660 lm
Source power:	48 W
Source efficiency:	160 lm/W
Device flux:	6590 lm
Device power:	52.5 W
Appliance efficiency:	126 lm/W
Glare Index Category:	D5

Product Sheet

Rev. 17/07/24

Classic Arm Suspension

Color Temperature: 3000 K

Type of optics: ME-01 Medium street

01CK4C40932CHM4

Colour: Sablé 100 Noir

Optical System

Source: LED R2

Color Temperature: 3000 K

Color Rendering Index (CRI): ≥ 70 Chromatic consistency (SDCM): ≤ 4

Type of optics: ME-01 Medium street

Optical group life: $>130.000\text{h}$ @700mA @Ta25°C TM21 L80B20, $>130.000\text{h}$ @700mA @Ta25°C TM21 L80B10

Photobiological safety class: EXEMPT GROUP

ULOR: 0%

DLOR: 100%

Light intensity category: G*3

BUG rating: B1-U0-G1

Normative References

EN60598-1 / EN60598-2-3 / EN62471

Installation and maintenance

Installation: arm / wall suspension

Pole diameter: $\varnothing 102$ mm \varnothing power cable: $10 \div 14$ mm

Cable Gland: PG16

Replaceable wiring plate: removable plate

Replaceable optical unit: each LED module is replaceable

Screen opening: glass holder frame opening, full block

Disconnecter: automatic (with terminal section 2.5 mm^2)**Flow adjustment**

On request

Virtual Midnight Teaching

X

Constant flow output (CLO)

X

DALI control

X

Mains voltage variation

X

Power line telemanagement (PLC)

X

Wireless remote management

X

MaterialsBody: die-cast aluminium alloy UNI EN AB 47100 (copper content $< 1\%$), upper dome with aluminium plate turning

Screen: tempered flat glass

Lenses: high-transparency PMMA

Fixing system: die-cast aluminium alloy UNI EN AB 47100 (copper content $< 1\%$)

Seals: expanded anti-age silicone foam

Screws: stainless steel AISI 304

Wiring plate: zinc-plated steel

Finish: phospho-chromatation treated and polyester powder-coated in 16 phases to increase weather resistance

Colors

■ Sablé 100 Noir

Code: **01CK4C40932CHM4**

Optional accessories



01AK979C0

L16 Male suspension kit
male 1/2 GAS. Colour: Sablé 100 Noir.



01AK907C0

L16 Male suspension kit
1" 1/2 GAS. Colour: Sablé 100 Noir.



01AK914C0

L17 Male suspension kit
3/4" GAS. Colour: Sablé 100 Noir.



01AK935C0

B15 Single curved arm
Ø 60 mm for poles Ø 102 mm. L=810
mm. Colour: Sablé 100 Noir.



01AK936C0

B16 Double curved arm
Ø 60 mm for poles Ø 102 mm. L=810
mm. Colour: Sablé 100 Noir.

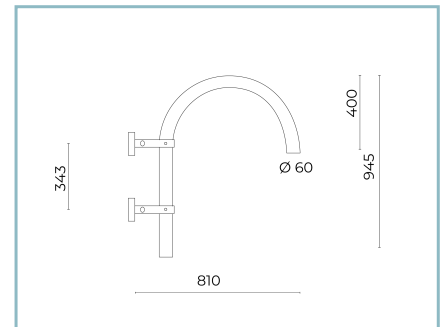

01AK950C0

B15-P Curved wall-mounted arm
Ø 60 mm. L=840 mm. Colour: Sablé
100 Noir.

NOTES

*Performance data

The values indicated in this data sheet are nominal values with a tolerance of +/-7%.

Source flux and source efficiency data refer to the LED module without optics; in case you are interested in the performance of the LED module complete with optical system, you must multiply the data reported by the factor 0.9.

General Data

The characteristics of the product listed may be subject to change and must be confirmed when ordering.

In order to promote constant updating of its products, Cariboni Group reserves the right to make changes without prior notice.