



General Features

Description: ceiling/Ground-mounted product

Insulation class: class I

Rated voltage: 230 V 50 Hz

Protection Grade: IP65

Impact protection: IK06

Power Factor: > 0.90

Ambient temperature Ta: -30°C +50°C

Weight: 3.00 kg

Driver: included

Marks and Certifications: CE

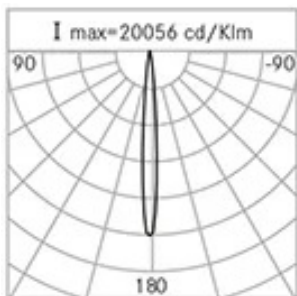

H (m)	Ø (m)	Em(lux)
5	0,93	397
4	0,74	619
3	0,56	1100
2	0,37	2476
1	0,19	9904

Performance Data*

LED Current:	500 mA
Source flux:	1460 lm
Source power:	14 W
Source efficiency:	104 lm/W
Device flux:	1050 lm
Device power:	16 W
Appliance efficiency:	66 lm/W

Product Sheet

Rev. 24/07/2024

Cube Floodlight

Size: medium
Color Temperature: 3000 K
Type of optics: C 8° Narrow beam

06LC3A9494A

Colour: Grey RAL9006

Optical System

Source: 9 LED

Color Temperature: 3000 K

Color Rendering Index (CRI): ≥ 80 Chromatic consistency (SDCM): ≤ 3

Type of optics: C 8° Narrow beam

Optical group life: $>60.000\text{h}$ @Ta25°C L80B10**Normative References**

EN60598-1 / EN60598-2-1 / EN62471

Installation and maintenance

Installation: wall / ground

Tilt: angular adjustment (with junction accessory kit)

Fixing: screw anchors

Ø power cable: $8 \div 13$ mm

Cable gland: M20

Disconnecter: automatic

MaterialsBody: die-cast aluminium alloy UNI EN AB 47100 (copper content $< 1\%$)

Screen: tempered flat glass

Lenses: PMMA

Seals: extruded anti-age silicone

Screws: stainless steel AISI 304

Finish: phospho-chromatation treated and polyester powder-coated in 16 phases to increase weather resistance

Colors

■ Grey RAL9006

Code: **06LC3A9494A**

Mandatory accessories



06LC2901A

Articulated joint for CUBE MEDIUM for wall mounting. Colour: grey RAL9006.

Optional accessories

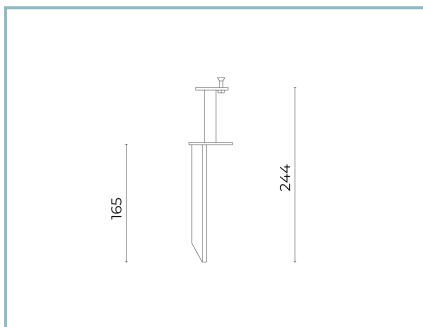

06LC901C0

Spike for ground installation CUBE MEDIUM.
Colour: Sablé 100 Noir.

NOTES

*Performance data

The values indicated in this data sheet are nominal values with a tolerance of +/-7%.

Source flux and source efficiency data refer to the LED module without optics; in case you are interested in the performance of the LED module complete with optical system, you must multiply the data reported by the factor 0.9.

General Data

The characteristics of the product listed may be subject to change and must be confirmed when ordering.

In order to promote constant updating of its products, Cariboni Group reserves the right to make changes without prior notice.