



### General Features

Description: LED luminaire for lighting streets, paths and urban spaces

Insulation class: class II

Rated voltage: 220-240 V / 50-60 Hz

Protection Grade: IP66

Impact protection: IK09

Surge protection device: integrated 10kV-10kA

Power Factor: > 0.95

Ambient temperature Ta: -30°C +50°C

Weight: 6.7 kg

Max exposed surface: 0.172 m<sup>2</sup>

Lateral exposed surface: 0.051 m<sup>2</sup>

Common mode surge protection: 10 kV

Overvoltage protection differential mode: 12 kV

Driver: included

Driver lifetime: F10 >100.000h @Ta25°C

Marks and Certifications: ENEC / CE

### Performance Data\*

	2700
LED Current:	1040 mA
Source flux:	10020 lm
Source power:	72.5 W
Source efficiency:	138 lm/W
Device flux:	8455 lm
Device power:	78 W
Appliance efficiency:	108 lm/W
Glare Index Category:	D4

**Product Sheet**

30/01/25

**Dasos Wall**

Size: small

Color Temperature: 2700 K

Type of optics: ME-05 Medium street

**DA1C48AA7K4182CCM400**

Colour: Sablé 100 Noir

**Optical System**

Source: LED R2

Color Temperature: 2700 K

Color Rendering Index (CRI): 70

Chromatic consistency (SDCM):  $\leq 3$ 

Type of optics: ME-05 Medium street

Optical group life: &gt;100.000 h @ Ta 25°C L90B10

Photobiological safety class: EXEMPT GROUP

ULOR: 0

DLOR: 1

Light intensity category: G\*3

BUG rating: B1-U0-G1

**Normative References**EN60598-1, EN60598-2-3, EN61547; EN62471, EN55015,  
EN61000-3-2, EN61000-3-3**Installation and maintenance**

Installation: wall / pole side

Pole diameter:  $\varnothing$  60 - 76 – 89 - 102 – 114 - 120 mm $\varnothing$  power cable: 10 ÷ 14 mm

Cable Gland: PG16

Power supply compartment: independent from the  
optical group**Flow adjustment**

Standard

Arrangement for Zhaga connector (Book 18)

X

**Materials**Body: aluminum alloy die casting UNI EN AB 47100  
(copper content < 1%)

Screen: 4 mm acid-etched tempered flat glass

Lenses: PMMA with high transparency

Seals: anti-aging silicone

Screws: INOX

Finish: phosphochromating and polyester powder coating  
made in 16 steps for the best weathering resistance**Colors**

■ Sablé 100 Noir

Code:

**DA1C48AA7K4182CCM400**

---

**Product Sheet**

30/01/25

**Dasos Wall**

Size: small

Color Temperature: 2700 K

Type of optics: ME-05 Medium street

**DA1C48AA7K4182CCM400**Colour: Sablé 100 Noir

---

**Mandatory accessories**

---

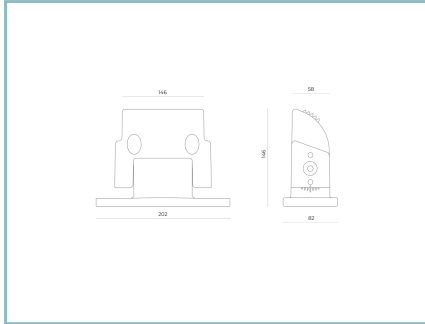

DA9013CC

Dasos swivel joint

---

**NOTES****\*Performance data**

The values indicated in this data sheet are nominal values with a tolerance of +/-7%.

Source flux and source efficiency data refer to the LED module without optics; in case you are interested in the performance of the LED module complete with optical system, you must multiply the data reported by the factor 0.9.

**General Data**

The characteristics of the product listed may be subject to change and must be confirmed when ordering.

In order to promote constant updating of its products, Cariboni Group reserves the right to make changes without prior notice.