



General Features

Description: LED luminaire for lighting streets, paths and urban spaces

Insulation class: class II

Rated voltage: 220-240 V / 50-60 Hz

Protection Grade: IP66

Impact protection: IK09

Surge protection device: integrated 10kV-10kA

Power Factor: > 0.95

Ambient temperature Ta: -30°C +50°C

Weight: 6.7 kg

Max exposed surface: 0.172 m²

Lateral exposed surface: 0.051 m²

Common mode surge protection: 10 kV

Overvoltage protection differential mode: 12 kV

Driver: included

Driver lifetime: F10 >100.000h @Ta25°C

Marks and Certifications: ENEC / CE

Performance Data*

	2700
LED Current:	1040 mA
Source flux:	12750 lm
Source power:	72.5 W
Source efficiency:	176 lm/W
Device flux:	10760 lm
Device power:	78 W
Appliance efficiency:	138 lm/W
Glare Index Category:	D4

Product Sheet

30/01/25

Dasos Wall

Size: small

Color Temperature: 2700 K

Type of optics: LT-63 Asymmetric beam

DA1C48AA8K4152CCM400

Colour: Sablé 100 Noir

Optical System

Source: LED R2

Color Temperature: 2700 K

Color Rendering Index (CRI): 80

Chromatic consistency (SDCM): ≤ 3

Type of optics: LT-63 Asymmetric beam

Optical group life: >100.000 h @ Ta 25°C L90B10

Photobiological safety class: EXEMPT GROUP

ULOR: 0

DLOR: 1

Light intensity category: G*6

BUG rating: B1-U0-G2

Normative ReferencesEN60598-1, EN60598-2-3, EN61547; EN62471, EN55015,
EN61000-3-2, EN61000-3-3**Installation and maintenance**

Installation: wall / pole side

Pole diameter: \varnothing 60 - 76 - 89 - 102 - 114 - 120 mm \varnothing power cable: 10 ÷ 14 mm

Cable Gland: PG16

Power supply compartment: independent from the
optical group**Flow adjustment**

Standard

Arrangement for Zhaga connector (Book 18)

X

MaterialsBody: aluminum alloy die casting UNI EN AB 47100
(copper content < 1%)

Screen: 4 mm acid-etched tempered flat glass

Lenses: PMMA with high transparency

Seals: anti-aging silicone

Screws: INOX

Finish: phosphochromating and polyester powder coating
made in 16 steps for the best weathering resistance**Colors**

■ Sablé 100 Noir

Code:

DA1C48AA8K4152CCM400

Product Sheet

30/01/25

Dasos Wall

Size: small

Color Temperature: 2700 K

Type of optics: LT-63 Asymmetric beam

DA1C48AA8K4152CCM400Colour: Sablé 100 Noir

Mandatory accessories

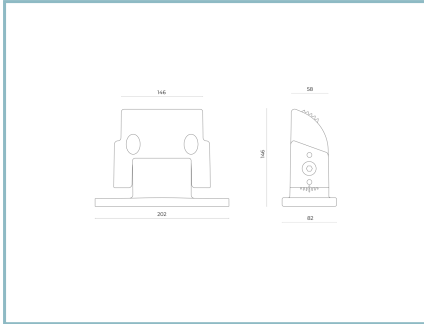

DA9013CC

Dasos swivel joint

NOTES***Performance data**

The values indicated in this data sheet are nominal values with a tolerance of +/-7%.

Source flux and source efficiency data refer to the LED module without optics; in case you are interested in the performance of the LED module complete with optical system, you must multiply the data reported by the factor 0.9.

General Data

The characteristics of the product listed may be subject to change and must be confirmed when ordering.

In order to promote constant updating of its products, Cariboni Group reserves the right to make changes without prior notice.