



General Features

Description: wall -mounted LED product

Insulation class: class II

Rated voltage: 220-240 V 50 Hz

Protection Grade: IP66

Impact protection: IK08

Power Factor: > 0.9

Ambient temperature Ta: -30°C +50°C

Weight: 0.60 kg

Max exposed surface: 0,01 m²

Lateral exposed surface: 0,005 m²

Driver: included

Marks and Certifications: CE

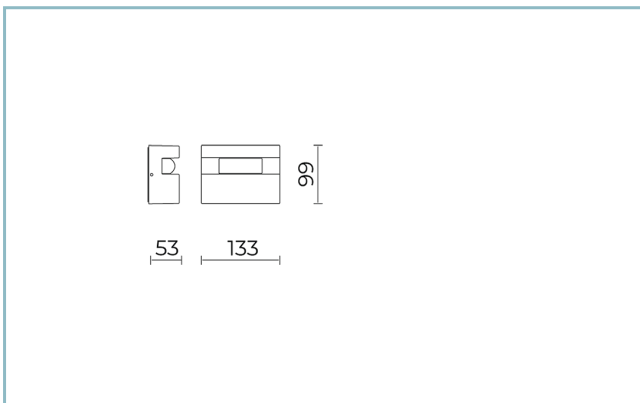

Performance Data*

Source flux:	350 lm
Source power:	4 W
Source efficiency:	88 lm/W
Device flux:	160 lm
Device power:	4.7 W
Appliance efficiency:	34 lm/W

Optical System

Source: LED

Color Temperature: 4000 K

Color Rendering Index (CRI): ≥ 80

Chromatic consistency (SDCM): ≤ 3

Type of optics: blade 5°x180°

Optical group life: >100.000h @Ta25°C L80B10

Photobiological safety class: EXEMPT GROUP

Normative References

EN60598-1 / EN60598-2-5 / EN62471 / EN61547

Installation and maintenance

Installation: ceiling / wall

Tilt: inclination of up to 5° to compensate for any sloping installation surfaces

Wiring: pre-wiring with outgoing cable L=1,5 m.

Double access point for the power cable: bottom or side.

The side inlet is designed to allow the connection to visible electrical installations, typical of historic facades.

Ø power cable: 3 ÷ 7 mm

Cable Gland: M12x1,5

Replaceable wiring plate: removable by unlocking grub screws

Materials

Body: die-cast aluminium alloy UNI EN AB 47100 (copper content < 1%)

Lenses: high-transparency PMMA

Seals: expanded anti-age silicone foam

Screws: stainless steel AISI 304 and AISI 316

Finish: phospho-chromatation treated and polyester powder-coated in 16 phases to increase weather resistance

Colors

■ Grey RAL9006

Code: **06EM1A13058A**

Mandatory accessories

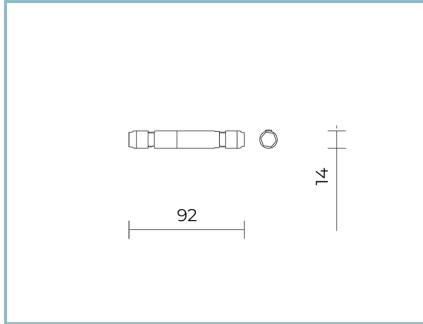

06GC902X0

B165 2-pole connector IP68

NOTES

*Performance data

The values indicated in this data sheet are nominal values with a tolerance of +/-7%.

Source flux and source efficiency data refer to the LED module without optics; in case you are interested in the performance of the LED module complete with optical system, you must multiply the data reported by the factor 0.9.

General Data

The characteristics of the product listed may be subject to change and must be confirmed when ordering.

In order to promote constant updating of its products, Cariboni Group reserves the right to make changes without prior notice.