



### General Features

Description: urban and public lighting luminaire

Insulation class: class II

Rated voltage: 220-240 V 50/60 Hz

Protection Grade: IP66

Impact protection: IK08

Surge protection device: integrated 10kV-10kA, Type 3, equipped with LED signaling and thermofusible for disconnection at the end of life; impulse withstand CL II 10kV DM

Power Factor: > 0.9

Ambient temperature Ta: -30°C +50°C

Weight: 11.00 kg

Max exposed surface: 0,25 m<sup>2</sup>

Lateral exposed surface: 0,14 m<sup>2</sup>

Common mode surge protection: 10 kV

Overtoltage protection differential mode: 10 kV

Driver: included

Marks and Certifications: ENEC / CE

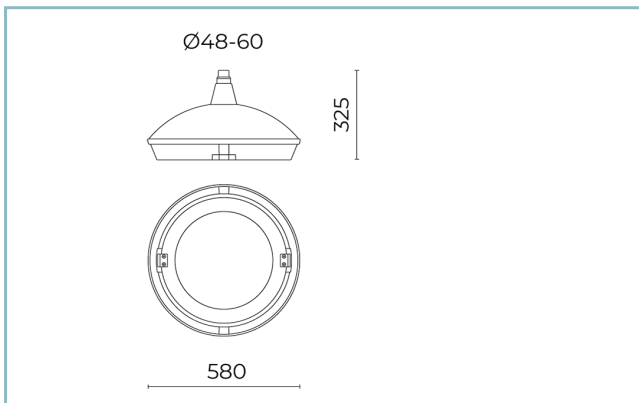

### Performance Data\*

LED Current:	350 mA
Source flux:	10650 lm
Source power:	58 W
Source efficiency:	184 lm/W
Device flux:	9160 lm
Device power:	63.5 W
Appliance efficiency:	144 lm/W
Glare Index Category:	D5

### Optical System

Source: LED R5
Color Temperature: 3000 K
Color Rendering Index (CRI): $\geq 70$
Chromatic consistency (SDCM): $\leq 4$
Type of optics: LT-06 Asymmetric beam
Optical group life: >130.000h @700mA @Ta25°C TM21 L80B20 >130.000h @700mA @Ta25°C TM21 L80B10
Photobiological safety class: EXEMPT GROUP
ULOR: 0%
DLOR: 100%
Light intensity category: G*6
BUG rating: B2-U0-G2

### Normative References

EN60598-1 / EN60598-2-3 / EN62471

### Installation and maintenance

Installation: arm suspension
Pole diameter: $\varnothing$ 48 - 60 - 76 - 114 mm (con accessori)
Wiring: Junction box IP68. The connection to the electrical backbone can be made without having to open the device
$\varnothing$ power cable: 10 $\div$ 14 mm
Cable Gland: PG16
Replaceable wiring plate: removable plate
Replaceable optical unit: each LED module is replaceable
Screen opening: glass holder frame opening, fall block
Disconnecter: automatic (with terminal section 2.5 mm <sup>2</sup> )

### Flow adjustment

On request

Virtual Midnight Teaching	X
Constant flow output (CLO)	X
Adjusting 1-10V	X
DALI control	X
Mains voltage variation	X
Power line telemanagement (PLC)	X
Wireless remote management	X

### Materials

Body: die-cast aluminium alloy UNI EN AB 47100 (copper content < 1%), upper dome with aluminium plate turning
Screen: tempered flat glass
Lenses: high-transparency PMMA
Fixing system: die-cast aluminium alloy UNI EN AB 47100 (copper content < 1%)
Seals: expanded anti-age silicone foam
Screws: stainless steel AISI 304
Wiring plate: zinc-plated steel
Finish: phospho-chromatation treated and polyester powder-coated in 16 phases to increase weather resistance

### Colors

■ Sablé 100 Noir Code: **01FK4G03937CHM4**

### Optional accessories



01AK979C0

L16 Male suspension kit  
male 1/2 GAS. Colour: Sablé 100 Noir.



01AK907C0

L16 Male suspension kit  
1" 1/2 GAS. Colour: Sablé 100 Noir.



01AK914C0

L17 Male suspension kit  
3/4" GAS. Colour: Sablé 100 Noir.



01AK935C0

B15 Single curved arm  
Ø 60 mm for poles Ø 102 mm. L=810  
mm. Colour: Sablé 100 Noir.



01AK936C0

B16 Double curved arm  
Ø 60 mm for poles Ø 102 mm. L=810  
mm. Colour: Sablé 100 Noir.

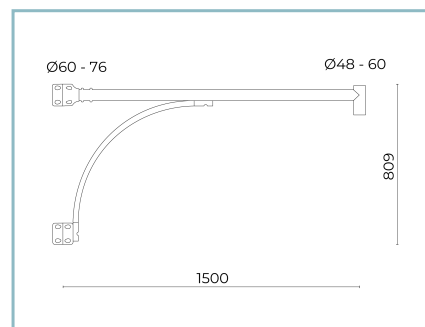

01AK933C0

B13 Single arched arm  
Ø 60 mm for poles Ø 60-76 mm.  
L=1500 mm. Colour: Sablé 100 Noir.



01AK934C0

B14 Double arched arm  
Ø 60 mm for poles Ø 60-76 mm.  
L=1500 mm. Colour: Sablé 100 Noir.



01AK941C0

B21 Single machined arm  
for poles Ø 114 mm. L=1000 mm.  
Colour: Sablé 100 Noir.

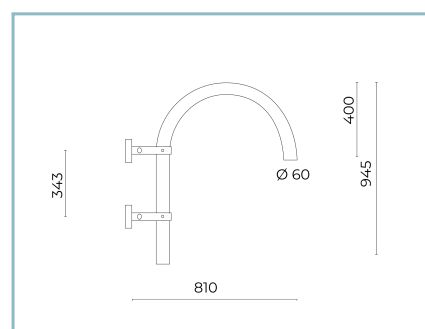

01AK950C0

B15-P Curved wall-mounted arm  
Ø 60 mm. L=840 mm. Colour: Sablé  
100 Noir.

---

**NOTES**

**\*Performance data**

The values indicated in this data sheet are nominal values with a tolerance of +/-7%.

Source flux and source efficiency data refer to the LED module without optics; in case you are interested in the performance of the LED module complete with optical system, you must multiply the data reported by the factor 0.9.

**General Data**

The characteristics of the product listed may be subject to change and must be confirmed when ordering.

In order to promote constant updating of its products, Cariboni Group reserves the right to make changes without prior notice.