



General Features

Description: wall-mounted LED product

Insulation class: class II

Rated voltage: 220-240 V 50/60 Hz

Protection Grade: IP66

Impact protection: IK08

Power Factor: > 0.9

Ambient temperature Ta: -30°C +50°C

Weight: 1.45 kg

Max exposed surface: 0,012 m²

Driver: included

Marks and Certifications: CE

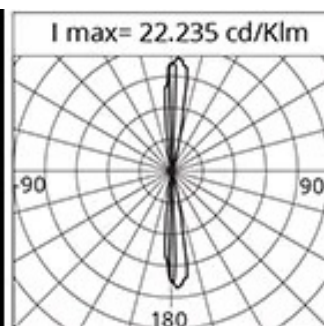
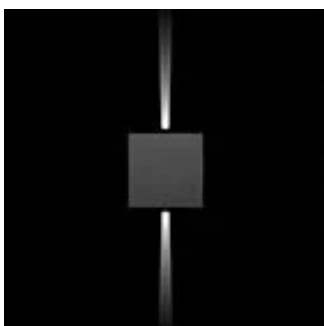

Performance Data*

LED Current:	650 mA
Source flux:	910 lm
Source power:	8.1 W
Source efficiency:	112 lm/W
Device flux:	345 lm
Device power:	9 W
Appliance efficiency:	38 lm/W

Optical System

Source: LED

Color Temperature: 4000 K

Color Rendering Index (CRI): ≥ 80

Chromatic consistency (SDCM): ≤ 3

Type of optics: 2x Blade 4°x17°

Optical group life: >60.000h @Ta25°C L80B10

Photobiological safety class: EXEMPT GROUP

Normative References

EN60598-1 / EN60598-2-5 / EN62471 / EN61547

Installation and maintenance

Installation: wall

Wiring: Rear cable entry, predisposition to in and out setup

Materials

Body: die-cast aluminium alloy UNI EN AB 47100 (copper content < 1%)

Screen: UV stabilized technopolymer

Lenses: high-transparency PMMA

Fixing system: base die-cast aluminium alloy UNI EN AB 47100 (copper content < 1%)

Seals: expanded anti-age silicone foam

Screws: stainless steel AISI 316

Finish: phospho-chromatation treated and polyester powder-coated in 16 phases to increase weather resistance

Colors

■ Corten

Code: **06GR2A40045U**

Product Sheet

Rev. 15/05/2023

Grapho

Options: ON-OFF

Color Temperature: 4000 K

Type of optics: 2x Blade 4°x17°

06GR2A40045UColour: Corten

NOTES***Performance data**

The values indicated in this data sheet are nominal values with a tolerance of +/-7%.

Source flux and source efficiency data refer to the LED module without optics; in case you are interested in the performance of the LED module complete with optical system, you must multiply the data reported by the factor 0.9.

General Data

The characteristics of the product listed may be subject to change and must be confirmed when ordering.

In order to promote constant updating of its products, Cariboni Group reserves the right to make changes without prior notice.