

### General Features

Description:	LED bollard
Insulation class:	class II
Rated voltage:	220-240 V 50/60 Hz
Protection Grade:	IP66
Impact protection:	IK10
Power Factor:	> 0.90
Ambient temperature Ta:	-30°C +50°C
Weight:	6 kg
Max exposed surface:	0.06 m <sup>2</sup>
Lateral exposed surface:	0.06 m <sup>2</sup>
Common mode surge protection:	10 kV
Overvoltage protection differential mode:	6 kV
Driver:	included
Driver lifetime:	>100.000h @700mA @Ta25°C / <0,2% 1000h
Marks and Certifications:	CE

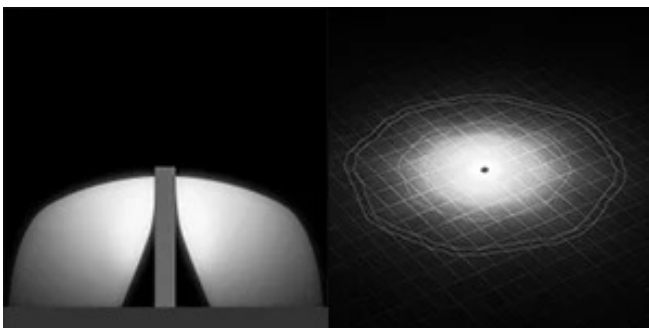
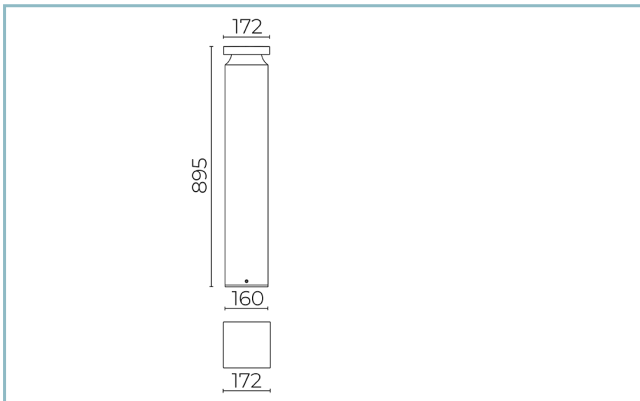

### Performance Data\*

LED Current:	540 mA
Source flux:	1990 lm
Source power:	10 W
Source efficiency:	199 lm/W
Device flux:	950 lm
Device power:	12 W
Appliance efficiency:	79 lm/W

---

### Optical System

Source: LED

Color Temperature: 3000 K

Color Rendering Index (CRI):  $\geq 80$

Chromatic consistency (SDCM):  $\leq 3$

Type of optics: RS-D 360° Rotosymmetric diffused beam

Optical group life:  $>100.000\text{h}$  @Ta25°C L90B10

Photobiological safety class: EXEMPT GROUP

ULOR: 0%

DLOR: 100%

### Normative References

EN60598-1 / EN60598-2-3 / EN62471 / EN61547

### Installation and maintenance

Installation: ground

Ø power cable:  $7 \div 13.5$  mm

Cable Gland: PG16

### Flow adjustment

Standard

DALI control

X

### Materials

Body: body, collimator and fixing base in die-cast aluminum alloy UNI EN AB 47100 (copper content  $< 1\%$ ); steam pole in extruded aluminium alloy

Lenses: wide opal polycarbonate

Seals: expanded anti-age silicone foam

Screws: stainless steel

Finish: phospho-chromatation treated and polyester powder-coated in 16 phases to increase weather resistance

### Colors

■ Sablé 100 Noir

Code: **06IO3E2890CHL**

## Optional accessories

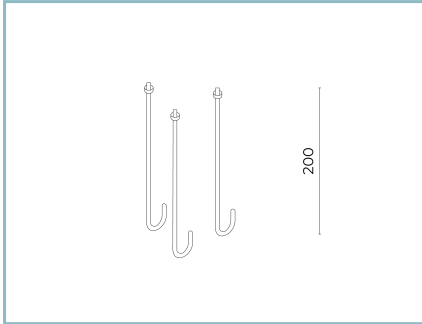

06PY999X0

Anchoring bolts kit  
L=200 mm.

## NOTES

### \*Performance data

The values indicated in this data sheet are nominal values with a tolerance of +/-7%.

Source flux and source efficiency data refer to the LED module without optics; in case you are interested in the performance of the LED module complete with optical system, you must multiply the data reported by the factor 0.9.

### General Data

The characteristics of the product listed may be subject to change and must be confirmed when ordering.

In order to promote constant updating of its products, Cariboni Group reserves the right to make changes without prior notice.