



General Features

Description: LED street fixture

Insulation class: class II

Rated voltage: 220-240 V 50/60 Hz

Protection Grade: IP66

Impact protection: IK08

Surge protection device: integrated 10kV-10kA, Type 3, equipped with LED signaling and thermofusible for disconnection at the end of life; impulse withstand CL II 10kV DM

Power Factor: > 0.9

Ambient temperature Ta: -30°C +50°C

Weight: 6.50 kg

Max exposed surface: 0,13 m²

Lateral exposed surface: 0,036 m²

Common mode surge protection: 10 kV

Overtoltage protection differential mode: 10 kV

Driver: included

Marks and Certifications: ENEC / ENEC+ / CE

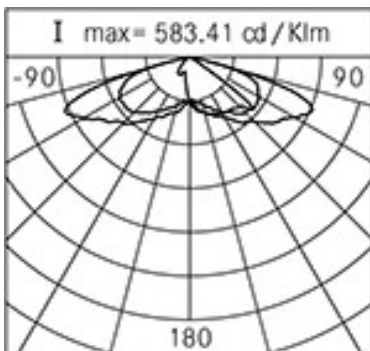

Performance Data*

LED Current:	350 mA
Source flux:	4355 lm
Source power:	23 W
Source efficiency:	189 lm/W
Device flux:	3745 lm
Device power:	26.5 W
Appliance efficiency:	141 lm/W
Glare Index Category:	D5

Optical System

Source: LED R2
Color Temperature: 3000 K
Color Rendering Index (CRI): ≥ 70
Chromatic consistency (SDCM): ≤ 4
Type of optics: LA-01 Wide street
Optical group life: >160.000h @700mA @Ta25°C TM21 L80B20 >160.000h @700mA @Ta25°C TM21 L80B10
Photobiological safety class: EXEMPT GROUP
ULOR: 0%
DLOR: 100%
Light intensity category: G*3
BUG rating: B1-U0-G1

Normative References

EN60598-1 / EN60598-2-3 / EN62471 / EN61547

Installation and maintenance

Installation: side pole / arm
Pole diameter: \varnothing 46 - 60 - 76 mm
Tilt: post top 0 +20° (step 5°); arm 0 -20° (step 5°)
Fixing: 2 x AISI 304 stainless steel securing bolts
\varnothing power cable: 10 ÷ 14 mm
Cable Gland: PG16
Replaceable wiring plate: tool less
Replaceable optical unit: tool less
Disconnecter: automatic (with terminal section 2.5 mm ²)
Power supply compartment: independent from the optical group

Flow adjustment

On request

Virtual Midnight Teaching	X
Constant flow output (CLO)	X
Adjusting 1-10V	X
DALI control	X
Mains voltage variation	X
Power line telemanagement (PLC)	X
Wireless remote management	X
Provision for motion/light sensors	X

Materials

Body: die-cast aluminium alloy UNI EN AB 47100 (copper content < 1%)
Screen: tempered flat glass 4 mm
Lenses: high-transparency PMMA
Fixing system: die-cast aluminium alloy UNI EN AB 47100 (copper content < 1%)
Seals: expanded anti-age silicone foam
Screws: stainless steel AISI 304
Wiring plate: self-extinguishable technopolymer V0
Finish: phospho-chromatation treated and polyester powder-coated in 16 phases to increase weather resistance

Colors

■ Grey RAL9006

Code: **01KI1C43931AHM4**

Complements



06GN902KO

Wall-mounted plate with a 90° inclination for fixtures with Ø 60 mm fastening part. Colour: grey RAL9006.



01AK921A0

B1 Single tubular arm Ø 60 mm for poles Ø 60-76 mm. L=550 mm. Colour: grey RAL9006.



01AK922A0

B2 Double tubular arm Ø 60 mm for poles Ø 60-76 mm. L=550 mm. Colour: grey RAL9006.



01AK951A0

B1-P Tubular wall-mounted arm Ø 60 mm. L=550 mm. Colour: grey RAL9006.



01AK969A0

B74 Single tubular arm Ø 60 mm with tensioning rod for poles Ø 60-76 mm. L=1050 mm (pole center-fitting center). Colour: grey RAL9006.



01AK968A0

B59 Double tubular arm Ø 60 mm with tensioning rod for poles Ø 60-76 mm. L=1050 mm (pole center-fitting center). Colour: grey RAL9006.

NOTES

*Performance data

The values indicated in this data sheet are nominal values with a tolerance of +/-7%.

Source flux and source efficiency data refer to the LED module without optics; in case you are interested in the performance of the LED module complete with optical system, you must multiply the data reported by the factor 0.9.

General Data

The characteristics of the product listed may be subject to change and must be confirmed when ordering.

In order to promote constant updating of its products, Cariboni Group reserves the right to make changes without prior notice.