



### General Features

Description: LED luminaire

Insulation class: classe II

Rated voltage: 220-240 V 50/60 Hz

Protection Grade: IP66

Impact protection: IK09

Surge protection device: integrated 10kV-10kA, integrated device complete with thermal fuse for disconnection at the end of life; impulse withstand CL II 10kV CM/DM

Power Factor: > 0.90

Ambient temperature Ta: -30°C +50°C

Weight: 8.00 kg

Max exposed surface: 0,16 m<sup>2</sup>

Lateral exposed surface: 0,068 m<sup>2</sup>

Common mode surge protection: 10 kV

Overtoltage protection differential mode: 10 kV

Driver: included

Marks and Certifications: ENEC / CE

### Performance Data\*

LED Current:	700 mA
Source flux:	3880 lm
Source power:	24 W
Source efficiency:	162 lm/W
Device flux:	2870 lm
Device power:	27 W
Appliance efficiency:	106 lm/W
Glare Index Category:	D4

### Optical System

Source: LED R1
Color Temperature: 3000 K
Color Rendering Index (CRI): $\geq 70$
Chromatic consistency (SDCM): $\leq 4$
Type of optics: ST-01 Narrow street
Optical group life: >160.000h @700mA @Ta25°C TM21 L80B20 >160.000h @700mA @Ta25°C TM21 L80B10
Photobiological safety class: EXEMPT GROUP
ULOR: 0%
DLOR: 100%
Light intensity category: G*3
BUG rating: B1-U0-G1

### Normative References

EN60598-1 / EN60598-2-3 / EN62471 / EN61547

### Installation and maintenance

Installation: post top, pole side
Pole diameter: (testa palo) $\varnothing$ 60 mm (76 - 102 mm con accessori), (lato palo) $\varnothing$ 102 mm
Fixing: 3 x AISI 304 stainless steel securing bolts
$\varnothing$ power cable: 8 $\div$ 13 mm
Cable gland: M20
Replaceable wiring plate: removable plate
Replaceable optical unit: LED disc replacement
Power supply compartment: independent from the optical system

### Flow adjustment

On request

Virtual Midnight Teaching	X
Constant flow output (CLO)	X
Adjusting 1-10V	X
DALI control	X
Mains voltage variation	X
Power line telemanagement (PLC)	X
Wireless remote management	X

### Materials

Body: die-cast aluminium alloy UNI EN AB 47100 (copper content < 1%)
Screen: tempered flat glass 5 mm
Lenses: high-transparency PMMA
Fixing system: die-cast aluminium alloy UNI EN AB 47100 (copper content < 1%)
Seals: expanded anti-age silicone foam
Screws: stainless steel AISI 304
Wiring plate: self-extinguishable technopolymer V0
Finish: phospho-chromatation treated and polyester powder-coated in 16 phases to increase weather resistance

### Colors

■ Sablé 100 Noir	Code: <b>01KA5B20930CHM4</b>
------------------	------------------------------

## Complements



01KA901C0

Cover for KALOS with 4 brackets on post top or on arm for upwards installation. Colour: Sablé 100 Noir.



01KA902C0

B35 Single arm  
L=1000 mm for poles Ø 102 mm with a Ø 60 mm fastening part H. 120 mm. Colour: Sablé 100 Noir.



01KA903C0

B36 Double arm  
L=1000 mm for poles Ø 102 mm with a Ø 60 mm fastening part H. 120 mm. Colour: Sablé 100 Noir.



01KA904C0

B37 Single arm  
L=500 mm for poles Ø 102 mm with a Ø 60 mm fastening part H. 120 mm. Colour: Sablé 100 Noir.



01KA905C0

B38 Double arm  
L=500 mm for poles Ø 102 mm with a Ø 60 mm fastening part H. 120 mm. Colour: Sablé 100 Noir.



01KA906C0

B39 Single arm  
L=1000 mm for poles Ø 102 mm. Colour: Sablé 100 Noir.



01KA907C0

B44 Double arm  
L=1000 mm for poles Ø 102 mm. Colour: Sablé 100 Noir.



01KA908C0

B45 Single arm  
L=500 mm for poles Ø 102 mm. Colour: Sablé 100 Noir.



01KA909C0

B46 Double arm  
L=500 mm for poles Ø 102 mm. Colour: Sablé 100 Noir.

**Product Sheet**

Rev. 11/07/2024

**Kalos Pole Side**

Options: 4 arms  
Color Temperature: 3000 K  
Type of optics: ST-01 Narrow street

**01KA5B20930CHM4**

Colour: Sablé 100 Noir

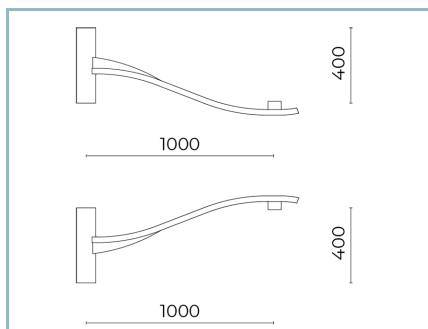

01KA910C0

B39-P Wall-mounted arm

L=1000 mm. UP / DOWN. Colour: Sablé 100 Noir.

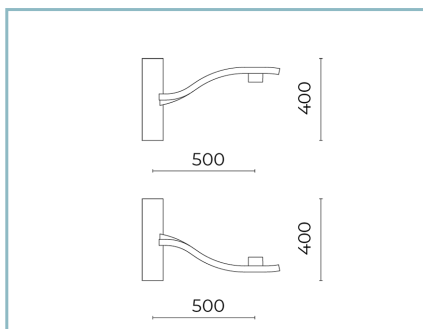

01KA911C0

B45-P Wall-mounted arm

L=500 mm. UP / DOWN. Colour: Sablé 100 Noir.

**NOTES**

**\*Performance data**

The values indicated in this data sheet are nominal values with a tolerance of +/-7%.

Source flux and source efficiency data refer to the LED module without optics; in case you are interested in the performance of the LED module complete with optical system, you must multiply the data reported by the factor 0.9.

**General Data**

The characteristics of the product listed may be subject to change and must be confirmed when ordering.

In order to promote constant updating of its products, Cariboni Group reserves the right to make changes without prior notice.