



General Features

Description: LED fitting for lighting façades, paths and urban spaces

Insulation class: Class II

Rated voltage: 220-240 V 50/60 Hz

Protection Grade: IP66

Impact protection: IK07

Surge protection device: integrated 2kV-4kV

Power Factor: > 0.95

Ambient temperature Ta: -30°C +50°C

Weight: 4.5 kg

Max exposed surface: 0.04 m²

Lateral exposed surface: 0.021 m²

Common mode surge protection: 2 kV

Overvoltage protection differential mode: 4 kV

Driver: included

Marks and Certifications: CE

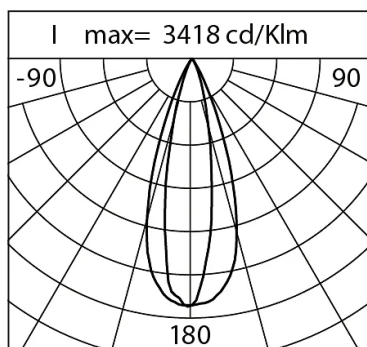

Performance Data*

Source flux:	1765 lm
Source power:	16 W
Source efficiency:	110 lm/W
Device flux:	1210 lm
Device power:	18 W
Appliance efficiency:	67 lm/W

Product Sheet

30/07/2024

Kinetic WallSize: Monoemissione
Color Temperature: 2200 K
Type of optics: G30° x 18°**06KI3C01201C11UHL**

Colour: Corten

Optical System

Source: 5 LED

Color Temperature: 2200 K

Color Rendering Index (CRI): ≥ 80 Chromatic consistency (SDCM): ≤ 3

Type of optics: G30° x 18°

Optical group life: >60.000 h @ Ta 25°C L80B10

Photobiological safety class: EXEMPT GROUP

ULOR: 0%

DLOR: 100%

BUG rating: B2-U0-G0

Normative ReferencesEN60598-1 / EN60598-2-3 / EN61547 / EN62471 / EN55015 /
EN61000-3-2 / EN61000-3-3**Installation and maintenance**

Installation: ground

Tilt: -90° +130° continuously adjustable

Ø power cable: 7 ÷ 13 mm

Cable Gland: M20

Power supply compartment: independent from the
optical group**Flow adjustment**

Standard

DALI control

X

MaterialsBody: die-cast aluminium alloy UNI EN AB 47100 (copper
content < 1%)

Screen: tempered flat glass 4 mm

Lenses: high-transparency PMMA

Seals: anti-age silicone

Screws: stainless steel AISI 304

Finish: phospho-chromatation treated and polyester
powder-coated in 16 phases to increase weather resistance**Colors** CortenCode: **06KI3C01201C11UHL**

Optional accessories



3 m

06KI912X0

KINETIC/KONO RGBW-TW 3m cable kit



5 m

06KI913X0

KINETIC/KONO RGBW-TW 5m cable kit



9 m

06KI914X0

9m KINETIC/KONO RGBW-TW cable kit



275

06KI911X0

Kinetic wall spacer

NOTES

*Performance data

The values indicated in this data sheet are nominal values with a tolerance of +/-7%.

Source flux and source efficiency data refer to the LED module without optics; in case you are interested in the performance of the LED module complete with optical system, you must multiply the data reported by the factor 0.9.

General Data

The characteristics of the product listed may be subject to change and must be confirmed when ordering.

In order to promote constant updating of its products, Cariboni Group reserves the right to make changes without prior notice.