

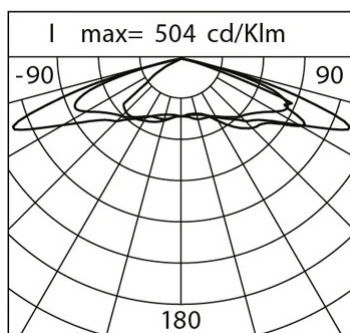

General Features

Description:	LED street fixture
Insulation class:	class II
Rated voltage:	220-240 V 50/60 Hz
Protection Grade:	IP66
Impact protection:	IK09
Surge protection device:	integrated 10kV-10kA
Power Factor:	> 0.9
Ambient temperature Ta:	-30°C +50°C
Weight:	4.2 kg
Max exposed surface:	0.11 m ²
Lateral exposed surface:	0.035 m ²
Common mode surge protection:	10 kV
Overvoltage protection differential mode:	10 kV
Driver:	included
Driver lifetime:	>100.000h @Ta25°C
Marks and Certifications:	ENEC / ENEC+ / CE

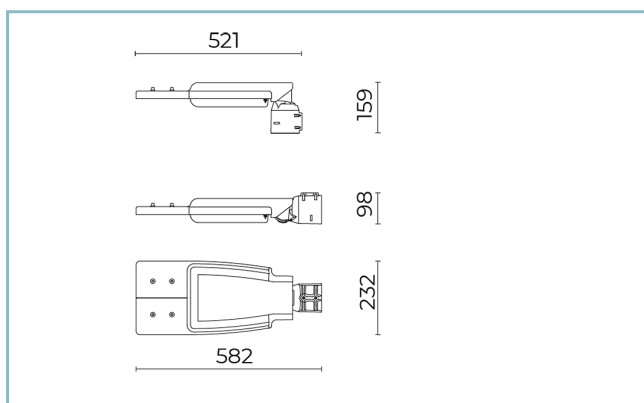

Performance Data*

Source flux:	9840 lm
Source power:	49 W
Source efficiency:	200 lm/W
Device flux:	8460 lm
Device power:	53 W
Appliance efficiency:	159 lm/W
Glare Index Category:	D4

Optical System

Source: LED R2

Color Temperature: 4000 K

Color Rendering Index (CRI): ≥ 70

Chromatic consistency (SDCM): ≤ 3

Type of optics: PB-01 Low pole

Optical group life: >100.000h @Ta25°C L90B10

Photobiological safety class: EXEMPT GROUP

ULOR: 0%

DLOR: 100%

Light intensity category: G*4

BUG rating: B2-U0-G2

Normative References

EN60598-1, EN60598-2-3, EN61547; EN62471, EN55015,
EN61000-3-2, EN61000-3-3

Installation and maintenance

Installation: side pole / arm

Pole diameter: \varnothing 46 - 60 - 76 mm

Tilt: post top 0 +90° (step 5°); arm 0 -90° (step 5°)

\varnothing power cable: 10 ÷ 14 mm

Cable Gland: PG16

Power supply compartment: independent from the optical group

Flow adjustment

On request

Virtual Midnight Teaching

X

Arrangement for Zhaga connector (Book 18)

X

Constant flow output (CLO)

X

Adjusting 1-10V

X

DALI control

X

Mains voltage variation

X

Wireless remote management

X

Provision for motion/light sensors

X

Materials

Body: die-cast aluminium alloy UNI EN AB 47100 (copper content < 1%)

Screen: tempered flat glass 4 mm

Lenses: high-transparency PMMA

Fixing system: die-cast aluminium alloy UNI EN AB 47100 (copper content < 1%)

Seals: anti-age silicone

Screws: stainless steel AISI 304

Finish: phospho-chromatation treated and polyester powder-coated in 16 phases to increase weather resistance

Colors

■ Grey RAL9006

Code: **01KO1C454016AHM4**

Complements



06GN902K0

Wall-mounted plate with a 90° inclination for fixtures with Ø 60 mm fastening part. Colour: grey RAL9006.



01AK968A0

B59 Double tubular arm Ø 60 mm with tensioning rod for poles Ø 60-76 mm. L=1050 mm (pole center-fitting center). Colour: grey RAL9006.



01AK969A0

B74 Single tubular arm Ø 60 mm with tensioning rod for poles Ø 60-76 mm. L=1050 mm (pole center-fitting center). Colour: grey RAL9006.



01AK951A0

B1-P Tubular wall-mounted arm Ø 60 mm. L=550 mm. Colour: grey RAL9006.



01AK921A0

B1 Single tubular arm Ø 60 mm for poles Ø 60-76 mm. L=550 mm. Colour: grey RAL9006.



01AK922A0

B2 Double tubular arm Ø 60 mm for poles Ø 60-76 mm. L=550 mm. Colour: grey RAL9006.

NOTES

*Performance data

The values indicated in this data sheet are nominal values with a tolerance of +/-7%.

Source flux and source efficiency data refer to the LED module without optics; in case you are interested in the performance of the LED module complete with optical system, you must multiply the data reported by the factor 0.9.

General Data

The characteristics of the product listed may be subject to change and must be confirmed when ordering.

In order to promote constant updating of its products, Cariboni Group reserves the right to make changes without prior notice.