



General Features

Description: orientable recessed LED lighting for diffused or accent lighting of architecture, urban spaces or structures in open areas

Insulation class: class III - power supply kit class II

Rated voltage: 220-240 V 50/60 Hz

Protection Grade: IP67

Impact protection: IK10

Power Factor: > 0.9

Ambient temperature Ta: -30°C +50°C

Weight: 2.00 kg

Driver: to be ordered separately

Marks and Certifications: CE

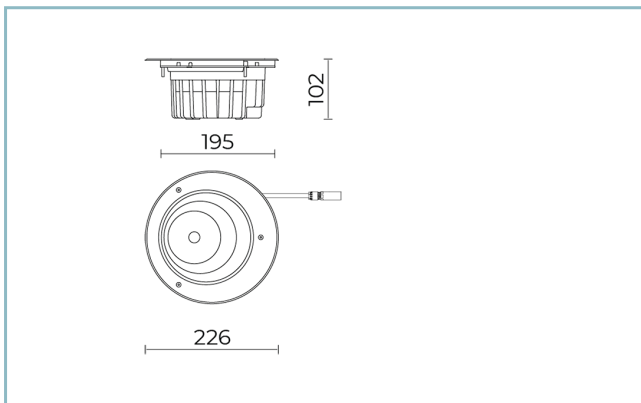

15W			
H (m)	Ø (m)	Em (lux)	
5	3.8	51	
4	3	80	
3	2.2	142	
2	1.5	320	
1	0.7	1281	

Performance Data*

LED Current:	450 mA
Source flux:	1675 lm
Source power:	15 W
Source efficiency:	112 lm/W
Device flux:	1175 lm
Device power:	18 W
Appliance efficiency:	65 lm/W

Optical System

Source: CoB LED

Color Temperature: 3000 K

Color Rendering Index (CRI): ≥ 90

Chromatic consistency (SDCM): ≤ 3

Type of optics: D 45° Wide Beam

Optical group life: >60.000h @Ta25°C L80B10

Photobiological safety class: EXEMPT GROUP

Normative References

EN60598-1 / EN60598-2-3 / EN62471 / EN61547

Installation and maintenance

Installation: ceiling/ground recessed

Tilt: Orientable Optical System. Tilt: 0° / -5° / -10° / -15°.

Rotation +359°.

Fixing: drive over version with recessed housing in plastic material to be buried in the floor

Wiring: Driver housing (to be ordered separately) IP67 pre-wired with M8x1 connector for the wiring from the driver to the fitting. It's supplied with cable H05RN-F \varnothing 6,5mm (ON-OFF version) or 2 cables H05RN-F diam \varnothing 6,5mm (DALI version). Electronic driver fed with 220-240V 50/60Hz with output 37V 450mA

Replaceable optical unit: each LED module is replaceable

Screen opening: opening by means of tools

Materials

Body: die-cast aluminium primary alloy UNI EN AB 44300

Lenses: highly transparent technopolymer lenses

Seals: anti-age silicone

Screws: stainless steel AISI 304

Finish: AISI 316L stainless steel frame with sandblasted and shoot peened finish

Colors

■ sandblasted stainless steel AISI 316L Code: **06KR1A169BOXS**

Complements



06KS909C0

B89 Connector 4 way IP68

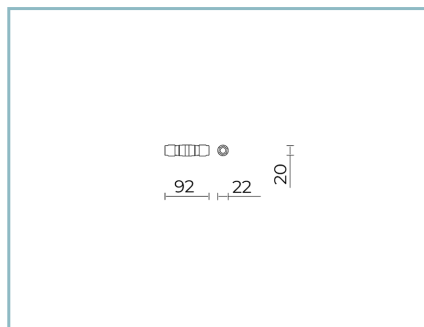

06KS918C0

B137 2 - way connector IP68

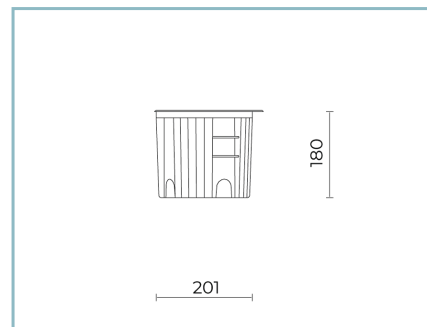

06KR901B0

B132 Drive over recessed housing made of polypropylene. Colour: black RAL9005.

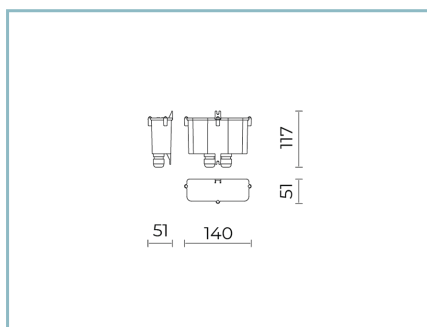

06KR904X0

B149 Driver
20W-240V IP67

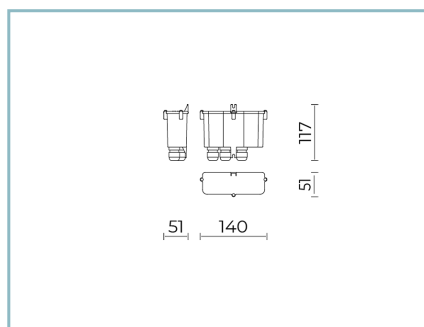

06KR905X0

B150 DALI driver
20W-240V IP67

NOTES

*Performance data

The values indicated in this data sheet are nominal values with a tolerance of +/-7%.

Source flux and source efficiency data refer to the LED module without optics; in case you are interested in the performance of the LED module complete with optical system, you must multiply the data reported by the factor 0.9.

General Data

The characteristics of the product listed may be subject to change and must be confirmed when ordering.

In order to promote constant updating of its products, Cariboni Group reserves the right to make changes without prior notice.