



### General Features

Description: LED luminaire

Insulation class: class II

Rated voltage: 220-240 V 50/60 Hz

Protection Grade: IP66

Impact protection: IK09

Surge protection device: integrated 10kV-10kA, Type 3, equipped with LED signaling and thermofusible for disconnection at the end of life; impulse withstand CL II 10kV DM

Power Factor: > 0.90

Ambient temperature Ta: -30°C +50°C

Weight: 3.50 kg

Max exposed surface: 0,06 m<sup>2</sup>

Lateral exposed surface: 0,030 m<sup>2</sup>

Common mode surge protection: 10 kV

Overtoltage protection differential mode: 10 kV

Driver: included

Driver lifetime: >100.000 h @ Ta 25°C (0,2% / 1000h)

Marks and Certifications: ENEC / CE

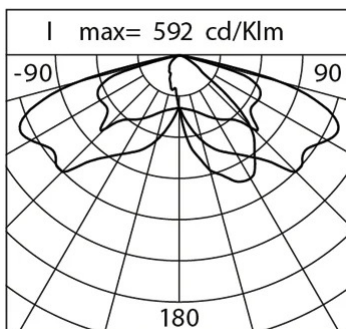

### Performance Data\*

Source flux:	3870 lm
Source power:	21.5 W
Source efficiency:	180 lm/W
Device flux:	3315 lm
Device power:	25 W
Appliance efficiency:	132 lm/W
Glare Index Category:	D5

### Optical System

Source: LED R1
Color Temperature: 2700 K
Color Rendering Index (CRI): $\geq 70$
Chromatic consistency (SDCM): $\leq 3$
Type of optics: ME-05 Medium street
Optical group life: $>100.000$ h @ Ta 25°C L90B10
Photobiological safety class: EXEMPT GROUP
ULOR: 0%
DLOR: 100%
Light intensity category: G*3
BUG rating: B1-U0-G1

### Normative References

EN60598-1 / EN60598-2-3 / EN62471 / EN61547

### Installation and maintenance

Installation: side pole / arm / wall
Pole diameter: $\varnothing 60 - 76 - 102$ mm
Tilt: (pole side, wall) continuous / stepped adjustment $-10^{\circ}$ $+190^{\circ}$ (step $5^{\circ}$ )
Fixing: upwards installation on a pole arm (for poles $\varnothing 60-76$ mm or poles $\varnothing 102$ mm) with adjustable joint made of die-cast aluminium alloy UNI EN AB 47100 (copper content $< 1\%$ ), polyester powder coated (Sablé 100 Noir); L-shaped joint made of die-cast aluminium alloy UNI EN AB 47100 (copper content $< 1\%$ ), polyester powder coated (Sablé 100 Noir), pole $\varnothing 76$ mm, with post-top reduction $\varnothing 60$ mm H. $\varnothing 90$ mm.
Wiring: pre-wired product
$\varnothing$ power cable: $10 \div 14$ mm
Cable Gland: PG16
Replaceable wiring plate: removable plate
Replaceable optical unit: LED disc replacement
Power supply compartment: independent from the optical system

### Flow adjustment

On request

Virtual Midnight Teaching	X
Constant flow output (CLO)	X
DALI control	X
Mains voltage variation	X
Power line telemanagement (PLC)	X
Wireless remote management	X

### Materials

Body: die-cast aluminium alloy UNI EN AB 47100 (copper content $< 1\%$ )
Screen: tempered flat glass
Lenses: high-transparency PMMA
Fixing system: die-cast aluminium alloy UNI EN AB 47100 (copper content $< 1\%$ )
Seals: expanded anti-age silicone foam
Screws: stainless steel AISI 304
Wiring plate: zinc-plated steel
Finish: phospho-chromatation treated and polyester powder-coated in 16 phases to increase weather resistance

### Colors

■ Sablé 100 Noir	Code: <b>06KS1B248818CHM4</b>
------------------	-------------------------------

### Mandatory accessories



06KS909C0

B89 Connector 4 way IP68

### Optional accessories



06ND901Y0

Diffuser  
made of transparent polycarbonate



06KS912C0

B92 Single arm  
for poles Ø 102 mm. L=350 mm. Colour:  
Sablé 100 Noir.



06KS913C0

B93 Single arm  
for poles Ø 102 mm. L=700 mm.  
Colour: Sablé 100 Noir.



06KS914C0

B94 Double arm  
for poles Ø 102 mm. L=350 mm. Colour:  
Sablé 100 Noir.



06KS915C0

B95 Double arm  
for poles Ø 102 mm. L=700 mm.  
Colour: Sablé 100 Noir.



06KS907C0

B87 Single arm  
for poles Ø 60-76 mm. L=350 mm.  
Colour: Sablé 100 Noir.

**Product Sheet**

Rev. 28/06/2024

**Kosmos Pole Side**

Size: small

Color Temperature: 2700 K

Type of optics: ME-05 Medium street

**06KS1B248818CHM4**

Colour: Sablé 100 Noir



06KS908C0

B88 Single arm  
for poles Ø 60-76 mm. L=700 mm.  
Colour: Sablé 100 Noir.



06KS910C0

B90 Double arm  
for poles Ø 60-76 mm. L=350 mm.  
Colour: Sablé 100 Noir.

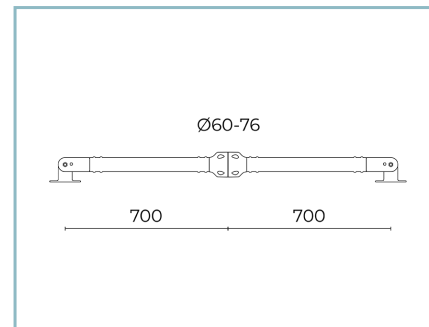

06KS911C0

B91 Double arm  
for poles Ø 60-76 mm. L=700 mm.  
Colour: Sablé 100 Noir.

**NOTES****\*Performance data**

The values indicated in this data sheet are nominal values with a tolerance of +/-7%.

Source flux and source efficiency data refer to the LED module without optics; in case you are interested in the performance of the LED module complete with optical system, you must multiply the data reported by the factor 0.9.

**General Data**

The characteristics of the product listed may be subject to change and must be confirmed when ordering.

In order to promote constant updating of its products, Cariboni Group reserves the right to make changes without prior notice.