



General Features

Description: LED luminaire

Insulation class: class II

Rated voltage: 220-240 V 50/60 Hz

Protection Grade: IP66

Impact protection: IK09

Surge protection device: integrated 10kV-10kA, Type 3, equipped with LED signaling and thermofusible for disconnection at the end of life; impulse withstand CL II 10kV DM

Power Factor: > 0.90

Ambient temperature Ta: -30°C +50°C

Weight: 7.50 kg

Max exposed surface: 0,140 m²

Lateral exposed surface: 0,063 m²

Common mode surge protection: 10 kV

Overtoltage protection differential mode: 10 kV

Driver: included

Driver lifetime: >100.000 h @ Ta 25°C (0,2% / 1000h)

Marks and Certifications: ENEC / CE

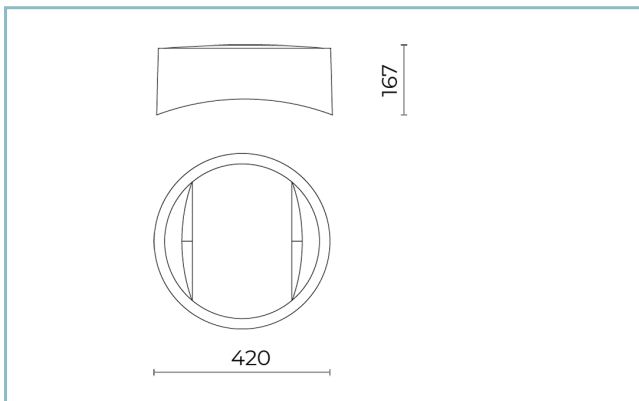

Performance Data*

Source flux:	2330 lm
Source power:	10.5 W
Source efficiency:	221 lm/W
Device flux:	2000 lm
Device power:	13 W
Appliance efficiency:	153 lm/W
Glare Index Category:	D6

Optical System

Source: LED R1

Color Temperature: 4000 K

Color Rendering Index (CRI): ≥ 70

Chromatic consistency (SDCM): ≤ 3

Type of optics: PB-01 Low pole

Optical group life: >100.000 h @ Ta 25°C L90B10

Photobiological safety class: EXEMPT GROUP

ULOR: 0%

DLOR: 100%

Light intensity category: G*4

BUG rating: B1-U0-G1

Normative References

EN60598-1 / EN60598-2-3 / EN62471 / EN61547

Installation and maintenance

Installation: side pole / arm / wall

Pole diameter: $\varnothing 60 - 76 - 102$ mm

Tilt: (pole side, wall) continuous / stepped adjustment -10° $+190^{\circ}$ (step 5°)

Fixing: upwards installation on a pole arm (for poles $\varnothing 60-76$ mm or poles $\varnothing 102$ mm) with adjustable joint made of die-cast aluminium alloy UNI EN AB 47100 (copper content $< 1\%$), polyester powder coated (Sablé 100 Noir); L-shaped joint made of die-cast aluminium alloy UNI EN AB 47100 (copper content $< 1\%$), polyester powder coated (Sablé 100 Noir), pole $\varnothing 76$ mm, with post-top reduction $\varnothing 60$ mm H. $\varnothing 90$ mm.

Wiring: pre-wired product

\varnothing power cable: $10 \div 14$ mm

Cable Gland: PG16

Replaceable wiring plate: removable plate

Replaceable optical unit: LED disc replacement

Power supply compartment: independent from the optical system

Flow adjustment

On request

Virtual Midnight Teaching	X
Constant flow output (CLO)	X
DALI control	X
Mains voltage variation	X
Power line telemanagement (PLC)	X
Wireless remote management	X

Materials

Body: die-cast aluminium alloy UNI EN AB 47100 (copper content $< 1\%$)

Screen: tempered flat glass

Lenses: high-transparency PMMA

Fixing system: die-cast aluminium alloy UNI EN AB 47100 (copper content $< 1\%$)

Seals: expanded anti-age silicone foam

Screws: stainless steel AISI 304

Wiring plate: zinc-plated steel

Finish: phospho-chromatation treated and polyester powder-coated in 16 phases to increase weather resistance

Colors

■ Sablé 100 Noir Code: **06KS2B224016CHM4**

Mandatory accessories



06KS909C0

B89 Connector 4 way IP68

Optional accessories



06KS912C0

B92 Single arm
for poles Ø 102 mm. L=350 mm. Colour:
Sablé 100 Noir.



06KS913C0

B93 Single arm
for poles Ø 102 mm. L=700 mm.
Colour: Sablé 100 Noir.



06KS914C0

B94 Double arm
for poles Ø 102 mm. L=350 mm. Colour:
Sablé 100 Noir.



06KS915C0

B95 Double arm
for poles Ø 102 mm. L=700 mm.
Colour: Sablé 100 Noir.



06KS907C0

B87 Single arm
for poles Ø 60-76 mm. L=350 mm.
Colour: Sablé 100 Noir.



06KS908C0

B88 Single arm
for poles Ø 60-76 mm. L=700 mm.
Colour: Sablé 100 Noir.



06KS910CO

B90 Double arm
for poles Ø 60-76 mm. L=350 mm.
Colour: Sablé 100 Noir.



06KS911CO

B91 Double arm
for poles Ø 60-76 mm. L=700 mm.
Colour: Sablé 100 Noir.

NOTES

*Performance data

The values indicated in this data sheet are nominal values with a tolerance of +/-7%.

Source flux and source efficiency data refer to the LED module without optics; in case you are interested in the performance of the LED module complete with optical system, you must multiply the data reported by the factor 0.9.

General Data

The characteristics of the product listed may be subject to change and must be confirmed when ordering.

In order to promote constant updating of its products, Cariboni Group reserves the right to make changes without prior notice.