



General Features

Description: LED luminaire

Insulation class: class II

Rated voltage: 220-240 V 50/60 Hz

Protection Grade: IP66

Impact protection: IK09

Surge protection device: integrated 10kV-10kA, Type 3, equipped with LED signaling and thermofusible for disconnection at the end of life; impulse withstand CL II 10kV DM

Power Factor: > 0.90

Ambient temperature Ta: -30°C +50°C

Weight: 7.50 kg

Max exposed surface: 0,140 m²

Lateral exposed surface: 0,063 m²

Common mode surge protection: 10 kV

Overvoltage protection differential mode: 10 kV

Driver: included

Driver lifetime: >100.000 h @ Ta 25°C (0,2% / 1000h)

Marks and Certifications: ENEC / CE

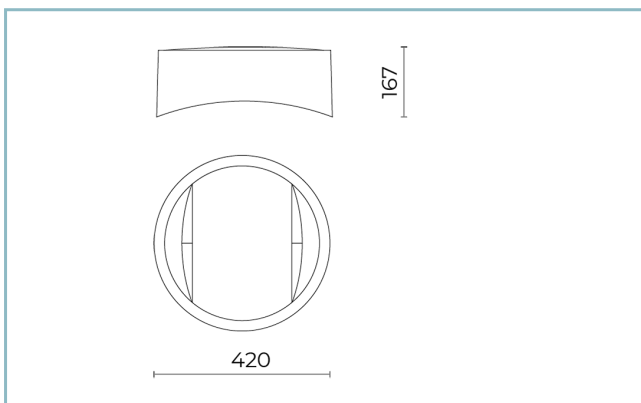

Performance Data*

Source flux:	6095 lm
Source power:	33.5 W
Source efficiency:	181 lm/W
Device flux:	5240 lm
Device power:	37 W
Appliance efficiency:	141 lm/W
Glare Index Category:	D3

Optical System

Source: LED R1
Color Temperature: 3000 K
Color Rendering Index (CRI): ≥ 70
Chromatic consistency (SDCM): ≤ 3
Type of optics: ST-02 Narrow street
Optical group life: >100.000 h @ Ta 25°C L90B10
Photobiological safety class: EXEMPT GROUP
ULOR: 0%
DLOR: 100%
Light intensity category: G*3
BUG rating: B1-U0-G1

Normative References

EN60598-1 / EN60598-2-3 / EN62471 / EN61547

Installation and maintenance

Installation: post top / side pole / arm / wall
Pole diameter: \varnothing 60 - 76 - 102 mm
Tilt: (pole side, wall) continuous / stepped adjustment -10° +190° (step 5°)
Fixing: post top with single arm, made of die-cast aluminium alloy UNI EN AB 47100 (copper content < 1%), polyester powder coated (Sablé 100 Noir); pole \varnothing 76 mm, with post top reduction \varnothing 60 mm H. 90 mm.
Wiring: pre-wired product
\varnothing power cable: 10 ÷ 14 mm
Cable Gland: PG16
Replaceable wiring plate: removable plate
Replaceable optical unit: LED disc replacement
Power supply compartment: independent from the optical system

Flow adjustment

On request

Virtual Midnight Teaching	X
Constant flow output (CLO)	X
DALI control	X
Mains voltage variation	X
Power line telemanagement (PLC)	X
Wireless remote management	X

Materials

Body: die-cast aluminium alloy UNI EN AB 47100 (copper content < 1%)
Screen: tempered flat glass
Lenses: high-transparency PMMA
Fixing system: die-cast aluminium alloy UNI EN AB 47100 (copper content < 1%)
Seals: expanded anti-age silicone foam
Screws: stainless steel AISI 304
Wiring plate: zinc-plated steel
Finish: phospho-chromatation treated and polyester powder-coated in 16 phases to increase weather resistance

Colors

■ Sablé 100 Noir	Code: 06KS2B272914CHM4
------------------	-------------------------------

Mandatory accessories



06KS906C0

B86 Joint for post top
Ø 60 mm. Colour: Sablé 100 Noir.



06KS909C0

B89 Connector 4 way IP68

Optional accessories



06KS901C0

B81 Arm for post top
Ø 60 mm. Fastening part H. Ø 90 mm.
Colour: Sablé 100 Noir.

NOTES

*Performance data

The values indicated in this data sheet are nominal values with a tolerance of +/-7%.

Source flux and source efficiency data refer to the LED module without optics; in case you are interested in the performance of the LED module complete with optical system, you must multiply the data reported by the factor 0.9.

General Data

The characteristics of the product listed may be subject to change and must be confirmed when ordering.

In order to promote constant updating of its products, Cariboni Group reserves the right to make changes without prior notice.