

Product Sheet

31.01.25

Kyros pole system

Size: small

Color Temperature: 2700 K

Type of optics: LA-03 Wide street

KY1C48AA779172AAM400

Colour: Grey RAL9006

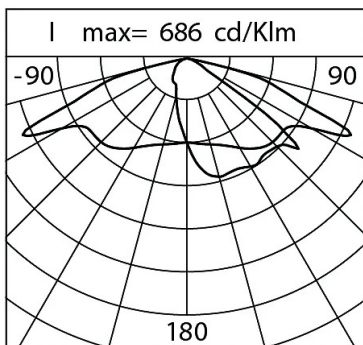
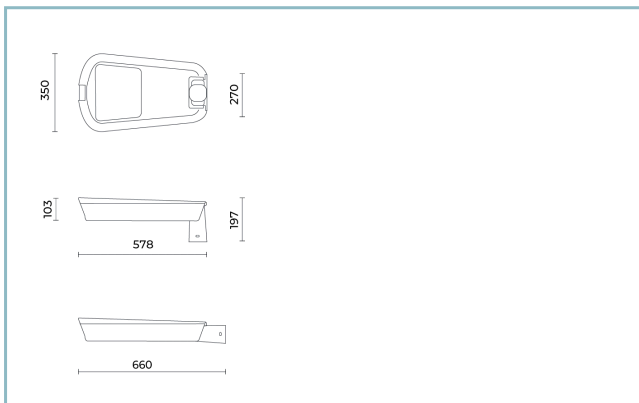
**General Features**

Description: LED luminaire for lighting streets and paths

Insulation class: class II

Rated voltage: 220-240 V / 50-60 Hz

Protection Grade: IP66

Impact protection: IK09

Surge protection device: integrated 10kV-10kA

Power Factor: > 0.95

Ambient temperature Ta: -30°C +50°C

Weight: 7.4 kg

Max exposed surface: 0.179 m²Lateral exposed surface: 0.059 m²

Common mode surge protection: 10 kV

Overvoltage protection differential mode: 10 kV

Driver: included

Driver lifetime: F10 >100.000h @Ta25°C

Marks and Certifications: ENEC / CE

Performance Data*

LED Current:	790 mA
Source flux:	9380 lm
Source power:	53.5 W
Source efficiency:	175 lm/W
Device flux:	7985 lm
Device power:	58 W
Appliance efficiency:	138 lm/W
Glare Index Category:	D4

Product Sheet

31.01.25

Kyros pole system

Size: small

Color Temperature: 2700 K

Type of optics: LA-03 Wide street

KY1C48AA779172AAM400

Colour: Grey RAL9006

Optical System

Source: LED R2

Color Temperature: 2700 K

Color Rendering Index (CRI): 70

Chromatic consistency (SDCM): ≤ 3

Type of optics: LA-03 Wide street

Optical group life: >100.000 h @ Ta 25°C L90B10

Photobiological safety class: EXEMPT GROUP

ULOR: 0

DLOR: 1

Light intensity category: G*3

BUG rating: B1-U0-G1

Normative References

EN60598-1, EN60598-2-3, EN61547; EN62471, EN55015, EN61000-3-2, EN61000-3-3

Installation and maintenance

Installation: post top / post top side

Pole diameter: Ø46 - Ø 60 mm

Ø power cable: 10 ÷ 14 mm

Cable Gland: PG16

Screen opening: Yes

Power supply compartment: independent from the optical group

Flow adjustment

Standard On request

Virtual Midnight Teaching

X

Arrangement for Zhaga connector (Book 18)

X

Constant flow output (CLO)

X

Adjusting 1-10V

X

DALI control

X

Mains voltage variation

X

Pilot line

X

Power line telemanagement (PLC)

X

Wireless remote management

X

Emergency lighting

X

Provision for motion/light sensors

X

Materials

Body: aluminum alloy die casting UNI EN AB 47100 (copper content < 1%)

Screen: technopolymer

Lenses: PMMA with high transparency

Seals: anti-aging silicone

Screws: stainless steel

Finish: phosphochromating and polyester powder coating made in 16 steps for the best weathering resistance

Colors

■ Grey RAL9006

Code:

KY1C48AA779172AAM400

Product Sheet

31.01.25

Kyros pole system

Size: small

Color Temperature: 2700 K

Type of optics: LA-03 Wide street

KY1C48AA779172AAM400Colour: Grey RAL9006

NOTES***Performance data**

The values indicated in this data sheet are nominal values with a tolerance of +/-7%.

Source flux and source efficiency data refer to the LED module without optics; in case you are interested in the performance of the LED module complete with optical system, you must multiply the data reported by the factor 0.9.

General Data

The characteristics of the product listed may be subject to change and must be confirmed when ordering.

In order to promote constant updating of its products, Cariboni Group reserves the right to make changes without prior notice.