



General Features

Description: LED fitting for lighting façades, paths and urban spaces

Insulation class: class II

Rated voltage: 220-240 V 50/60 Hz

Protection Grade: IP66

Impact protection: IK09

Surge protection device: integrated 10kV-10kA

Power Factor: > 0.95

Ambient temperature Ta: -30°C +50°C

Weight: 3.6 kg

Max exposed surface: 0.073 m²

Lateral exposed surface: 0.017 m²

Common mode surge protection: 10 kV

Overvoltage protection differential mode: 10 kV

Driver: included

Marks and Certifications: ENEC / ENEC+ / CE

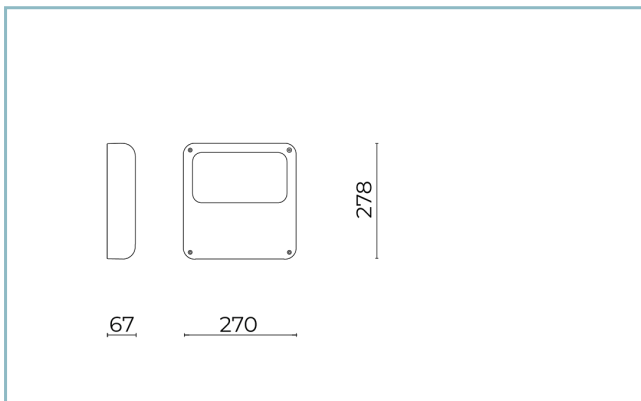

H (m)	Ø (m)	Em (lux)
1	0.8	1034
2	1.5	258
3	2.5	115
4	3.3	65
5	4.2	41

Performance Data*

LED Current:	500 mA
Source flux:	2455 lm
Source power:	17 W
Source efficiency:	144 lm/W
Device flux:	1730 lm
Device power:	19 W
Appliance efficiency:	91 lm/W
Glare Index Category:	D6

Optical System

Source: LED L3

Color Temperature: 3000 K

Color Rendering Index (CRI): ≥ 80

Chromatic consistency (SDCM): ≤ 3

Type of optics: W-W Wall washer

Optical group life: >100.000h @ Ta 25°C L90B10

Photobiological safety class: EXEMPT GROUP

ULOR: 0%

DLOR: 100%

Light intensity category: G*6

BUG rating: B1-U0-G0

Normative References

EN60598-1 / EN60598-2-5 / EN62471 / EN61547

Installation and maintenance

Installation: wall, ceiling, ground, pole side

Tilt: (wall, ground) with adjustable joint can be tilted from -90° to +90° and rotated from -15° to +15°; the pointing and locking system is continuously adjustable; (pole side) with adjustable joint can be tilted from -70° to +90° and rotated by 0° / 180°; the pointing and locking system is continuously adjustable.

Ø power cable: 10 ÷ 14 mm

Cable Gland: PG16

Power supply compartment: independent from the optical group

Flow adjustment

Standard

DALI control

X

Materials

Body: die-cast aluminium alloy UNI EN AB 47100 (copper content < 1%)

Screen: tempered flat glass 4 mm

Lenses: high-transparency PMMA

Seals: anti-age silicone

Screws: stainless steel AISI 304

Finish: phospho-chromatation treated and polyester powder-coated in 16 phases to increase weather resistance

Colors

■ Sablé 100 Noir

Code: **06LN1B2509C2CHL**

Mandatory accessories



06LN901C0

B225 Adjustable joint.
Colour: Sablé 100 Noir.

Optional accessories



06LN914J0

B246 Kit metal anchors LEVANTE 2.0

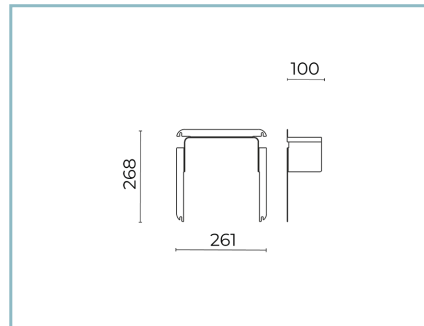

06LN911B0

B239 Lightshade visor kit.
Levante 2.0 x-small. Colour: black
RAL9005.

NOTES

*Performance data

The values indicated in this data sheet are nominal values with a tolerance of +/-7%.

Source flux and source efficiency data refer to the LED module without optics; in case you are interested in the performance of the LED module complete with optical system, you must multiply the data reported by the factor 0.9.

General Data

The characteristics of the product listed may be subject to change and must be confirmed when ordering.

In order to promote constant updating of its products, Cariboni Group reserves the right to make changes without prior notice.