



### General Features

Description: LED luminaire

Insulation class: class II

Rated voltage: 220-240 V 50/60 Hz

Protection Grade: IP66

Impact protection: IK10

Surge protection device: integrated 10kV-10kA, Type 3, equipped with LED signaling and thermofusible for disconnection at the end of life; impulse withstand CL II 10kV DM

Power Factor: > 0.9

Ambient temperature Ta: -30°C +50°C

Weight: 8.00 kg

Max exposed surface: 0,14 m<sup>2</sup>

Lateral exposed surface: 0,03 m<sup>2</sup>

Common mode surge protection: 10 kV

Overtoltage protection differential mode: 10 kV

Driver: included

Marks and Certifications: ENEC / CE

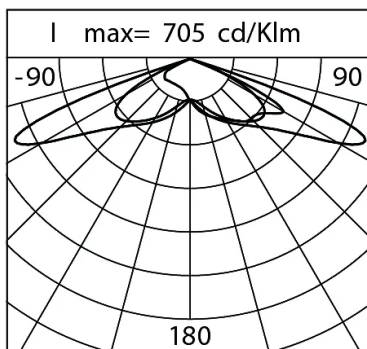

### Performance Data\*

LED Current:	350 mA
Source flux:	11620 lm
Source power:	62 W
Source efficiency:	187 lm/W
Device flux:	9180 lm
Device power:	68 W
Appliance efficiency:	135 lm/W
Glare Index Category:	D6

### Optical System

Source: LED L4
Color Temperature: 3000 K
Color Rendering Index (CRI): $\geq 70$
Chromatic consistency (SDCM): $\leq 3$
Type of optics: LT-62 Asymmetric beam
Optical group life: >100.000h @700mA @Ta25°C TM21 L80B10
Photobiological safety class: EXEMPT GROUP
ULOR: 0%
DLOR: 100%
Light intensity category: G*4
BUG rating: B2-U0-G2

### Normative References

EN60598-1 / EN60598-2-3 / EN60598-2-5 / EN62471 / EN61547

### Installation and maintenance

Installation: wall / ground / pole
Pole diameter: $\varnothing$ 60 - 76 - 102 mm
Tilt: fastened or adjustable installation
Fixing: single or double fixed collar for pole $\varnothing$ 60-76 mm (LIT SMALL) and for pole $\varnothing$ 102mm (LIT MEDIUM/LARGE) polyester powder coated (Sablé 100 Noir)
Wiring: pre-wired product
$\varnothing$ power cable: 10 ÷ 14 mm
Cable Gland: PG16

### Flow adjustment

On request

Virtual Midnight Teaching	X
Arrangement for Zhaga connector (Book 18)	X
Constant flow output (CLO)	X
Adjusting 1-10V	X
DALI control	X
Wireless remote management	X
Provision for motion/light sensors	X

### Materials

Body: die-cast aluminium alloy UNI EN AB 47100 (copper content < 1%)
Screen: tempered flat glass
Lenses: high-transparency PMMA
Fixing system: die-cast aluminium alloy UNI EN AB 47100 (copper content < 1%)
Seals: anti-age silicone
Screws: stainless steel AISI 304
Wiring plate: zinc-plated steel
Finish: phospho-chromatation treated and polyester powder-coated in 16 phases to increase weather resistance

### Colors

■ Sablé 100 Noir	Code: <b>06LT8B639A2CHM4</b>
------------------	------------------------------

**Mandatory accessories**



06LT912C0

B121 Single collar  
for poles Ø102mm. Colour: Sablé 100  
Noir.

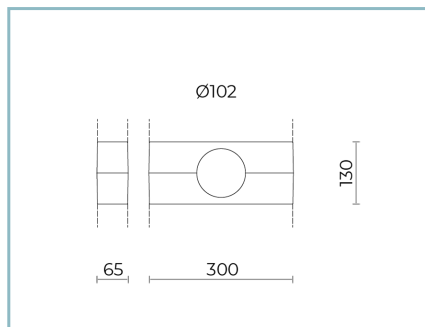

06LT913C0

B122 Double collar  
for poles Ø102mm. Colour: Sablé 100  
Noir.



06LT937C0

B174 Single collar  
for poles Ø76mm. Colour: Sablé 100  
Noir.



06LT935C0

B172 Single collar  
for poles Ø60mm. Colour: Sablé 100  
Noir.

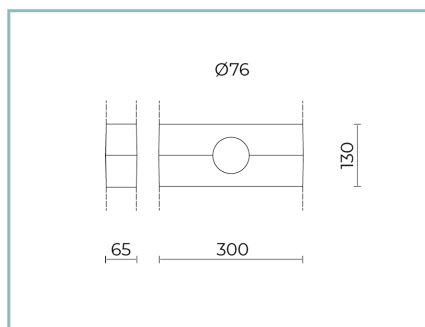

06LT938C0

B175 Double collar  
for poles Ø76mm. Colour: Sablé 100  
Noir.



06LT936C0

B173 Double collar  
for poles Ø60mm. Colour: Sablé 100  
Noir.



06KS909C0

B89 Connector 4 way IP68

---

**Product Sheet**

Rev. 10/07/2024

**Lit Poles**

Size: large

Color Temperature: 3000 K

Type of optics: LT-62 Asymmetric beam

**06LT8B639A2CHM4**Colour: Sablé 100 Noir

---

---

**NOTES****\*Performance data**

The values indicated in this data sheet are nominal values with a tolerance of +/-7%.

Source flux and source efficiency data refer to the LED module without optics; in case you are interested in the performance of the LED module complete with optical system, you must multiply the data reported by the factor 0.9.

**General Data**

The characteristics of the product listed may be subject to change and must be confirmed when ordering.

In order to promote constant updating of its products, Cariboni Group reserves the right to make changes without prior notice.