

General Features

Description: wall-mounted LED product

Insulation class: class III

Rated voltage: 650 mA

Protection Grade: IP66

Impact protection: IK08

Ambient temperature Ta: -30°C +50°C

Weight: 0.35 kg

Driver: remote (to be ordered separately)

Marks and Certifications: CE

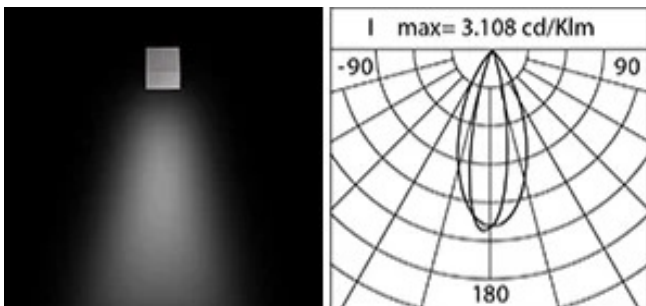
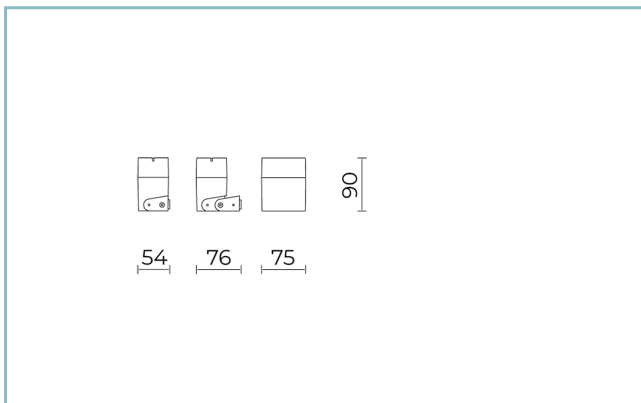

Performance Data*

LED Current:	650 mA
Source flux:	425 lm
Source power:	4 W
Source efficiency:	106 lm/W
Device flux:	140 lm
Device power:	4 W
Appliance efficiency:	35 lm/W

Optical System

Source: LED

Color Temperature: 3000 K

Color Rendering Index (CRI): ≥ 80

Chromatic consistency (SDCM): ≤ 3

Type of optics: 1x Wide Beam 50°x20°

Optical group life: >60.000h @Ta25°C L80B10

Normative References

EN60598-1 / EN60598-2-5 / EN62471 / EN61547

Installation and maintenance

Installation: ceiling / wall / ground

Tilt: continuous adjustment -15° + 105°

Fixing: The fastening system allows a continuously adjustable inclination -5° +105°

Wiring: Pre-wiring with outgoing cable L=1 m

Flow adjustment

Standard

DALI control

X

Materials

Body: die-cast aluminium alloy UNI EN AB 47100 (copper content < 1%)

Screen: tempered flat glass

Lenses: high-transparency PMMA

Fixing system: die-cast aluminium alloy UNI EN AB 47100 (copper content < 1%) bracket

Seals: high-density rubber compound, anti-aging type

Screws: stainless steel AISI 316

Finish: phospho-chromatation treated and polyester powder-coated in 16 phases to increase weather resistance

Colors

■ Sablé 100 Noir

Code: **06MK1A20947C**

Mandatory accessories

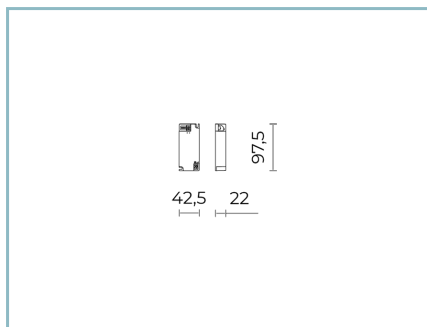

06MK900X0

D3 Driver
30W 650mA IP20 1-6 MIKRO

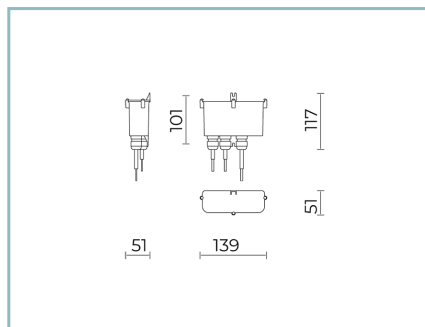

06MK901X0

D4 KIT DRIVER
650mA IP67 1-6 MIKRO

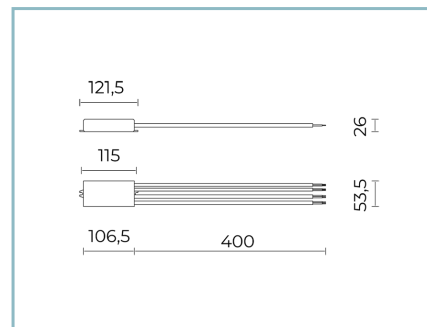

06MK902X0

D5 DALI DRIVER 30W
650mA IP68 1-6 MIKRO

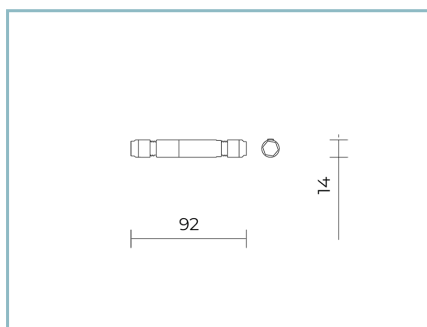

06GC902X0

B165 2-pole connector IP68

Optional accessories

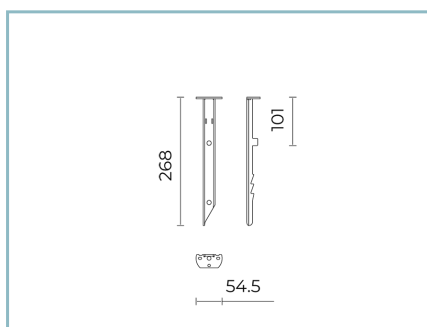

06AK957B0

I2 Spike for ground installation.
Colour: black RAL9005

Product Sheet

Rev. 18/01/2023

Mikro

Color Temperature: 3000 K

Type of optics: 1x Wide Beam 50°x20°

06MK1A20947CColour: Sablé 100 Noir

NOTES***Performance data**

The values indicated in this data sheet are nominal values with a tolerance of +/-7%.

Source flux and source efficiency data refer to the LED module without optics; in case you are interested in the performance of the LED module complete with optical system, you must multiply the data reported by the factor 0.9.

General Data

The characteristics of the product listed may be subject to change and must be confirmed when ordering.

In order to promote constant updating of its products, Cariboni Group reserves the right to make changes without prior notice.