



### General Features

Description: LED fitting for lighting walkways and urban spaces

Insulation class: class II

Rated voltage: 220-240 V 50/60 Hz

Protection Grade: IP66

Impact protection: IK09

Surge protection device: integrated 10kV-10kA, Type 3, equipped with LED signaling and thermofusible for disconnection at the end of life; impulse withstand CL II 10kV DM

Power Factor: > 0.90

Ambient temperature Ta: -30°C +50°C

Weight: 4.50 kg

Max exposed surface: 0,06 m<sup>2</sup>

Lateral exposed surface: 0,030 m<sup>2</sup>

Common mode surge protection: 10 kV

Overvoltage protection differential mode: 10 kV

Driver: included

Driver lifetime: >100.000 h @ Ta 25°C (0,2% / 1000h)

Marks and Certifications: CE

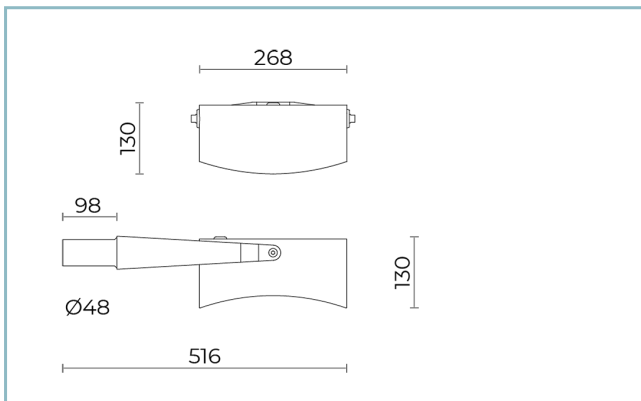

### Performance Data\*

Source flux:	4720 lm
Source power:	27.5 W
Source efficiency:	172 lm/W
Device flux:	4040 lm
Device power:	31 W
Appliance efficiency:	130 lm/W
Glare Index Category:	D6

### Optical System

Source: LED R1

Color Temperature: 2700 K

Color Rendering Index (CRI):  $\geq 70$

Chromatic consistency (SDCM):  $\leq 3$

Type of optics: LT-64 Asymmetric beam with backlight

Optical group life:  $>100.000$  h @ Ta 25°C L90B10

Photobiological safety class: EXEMPT GROUP

ULOR: 0%

DLOR: 100%

Light intensity category: G\*3

BUG rating: B1-U0-G1

### Normative References

EN60598-1 / EN60598-2-3 / EN62471 / EN61547

### Installation and maintenance

Installation: pole side

Tilt: continuous adjustment

Fixing: arm  $\varnothing$  48 mm

Wiring: pre-wired product

$\varnothing$  power cable: 10 ÷ 14 mm

Cable Gland: PG16

Replaceable wiring plate: removable plate

Replaceable optical unit: LED disc replacement

Power supply compartment: independent from the optical system

### Flow adjustment

On request

Virtual Midnight Teaching

X

DALI control

X

### Materials

Body: die-cast aluminium alloy UNI EN AB 47100 (copper content  $< 1\%$ )

Screen: tempered flat glass

Lenses: high-transparency PMMA

Fixing system: die-cast aluminium alloy UNI EN AB 47100 (copper content  $< 1\%$ )

Seals: expanded anti-age silicone foam

Screws: stainless steel AISI 304

Wiring plate: zinc-plated steel

Finish: phospho-chromatation treated and polyester powder-coated in 16 phases to increase weather resistance

### Colors

■ Sablé 100 Noir

Code: **06ND1B260825CHM4**

---

## Optional accessories

---



06ND901Y0

Diffuser  
made of transparent polycarbonate

---

## NOTES

### \*Performance data

The values indicated in this data sheet are nominal values with a tolerance of +/-7%.

Source flux and source efficiency data refer to the LED module without optics; in case you are interested in the performance of the LED module complete with optical system, you must multiply the data reported by the factor 0.9.

### General Data

The characteristics of the product listed may be subject to change and must be confirmed when ordering.

In order to promote constant updating of its products, Cariboni Group reserves the right to make changes without prior notice.