



General Features

Description: LED floodlight

Insulation class: class II

Rated voltage: 220-240 V 50/60 Hz

Protection Grade: IP66

Impact protection: IK07

Power Factor: > 0.9

Ambient temperature Ta: -30°C +50°C

Weight: 1.5 kg

Max exposed surface: 0,011 m²

Lateral exposed surface: 0,006 m²

Driver: included

Marks and Certifications: CE

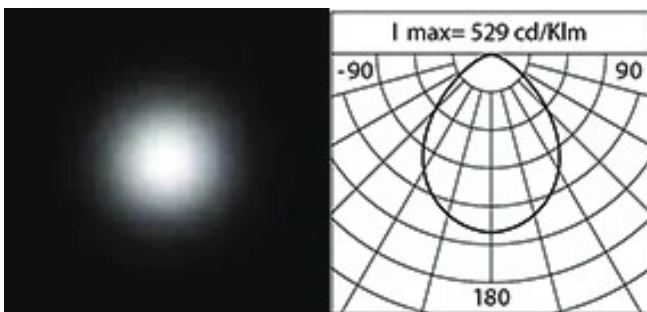
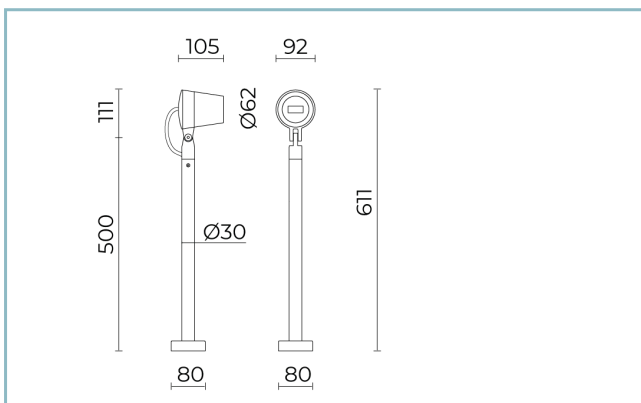

Performance Data*

LED Current:	450 mA
Source flux:	470 lm
Source power:	5.6 W
Source efficiency:	84 lm/W
Device flux:	220 lm
Device power:	7 W
Appliance efficiency:	31 lm/W
Glare Index Category:	D6

Optical System

Source: LED

Color Temperature: 3000 K

Color Rendering Index (CRI): ≥ 80

Chromatic consistency (SDCM): ≤ 3

Type of optics: U-D 90° Diffused beam

Optical group life: >100.000h @Ta25°C L80B10

Photobiological safety class: EXEMPT GROUP

Normative References

EN60598-1 / EN60598-2-5 / EN62471 / EN61547

Installation and maintenance

Installation: ground

Pole diameter: \varnothing 30mm

Tilt: -90° +45°, continously-adjustable pointing and locking system

Fixing: base plate made of sheet steel for fixing with screw anchors or anchoring bolts (to be ordered separately).

Bollard made of aluminium alloy EN AW 6026.

Wiring: pre-wired product, cable L=1,5m

Cable Gland: M12x1,5

Materials

Body: die-cast aluminium alloy UNI EN AB 47100 (copper content < 1%)

Screen: acid-etched glass

Lenses: high-transparency PMMA

Seals: expanded anti-age silicone foam

Screws: stainless steel AISI 304

Finish: phospho-chromatation treated and polyester powder-coated in 16 phases to increase weather resistance

Colors

■ Grey RAL9006

Code: **06OM5A139C4A**

Mandatory accessories



06GC902X0

B165 2-pole connector IP68



06OM902X0

D6 DALI DRIVER
20W 24V IP20 MAX 2 OMIKRON MINI

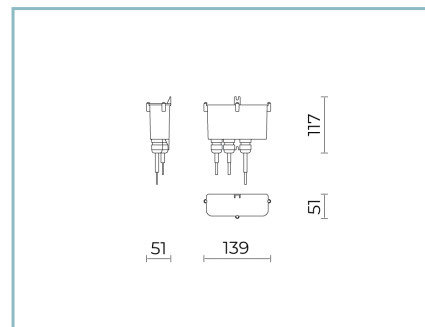

06OM903X0

D7 KIT DALI DRIVER
20W 24V IP67 MAX 2 OMIKRON MINI

Optional accessories



06AK957B0

I2 Spike for ground installation.
Colour: black RAL9005

NOTES

*Performance data

The values indicated in this data sheet are nominal values with a tolerance of +/-7%.

Source flux and source efficiency data refer to the LED module without optics; in case you are interested in the performance of the LED module complete with optical system, you must multiply the data reported by the factor 0.9.

General Data

The characteristics of the product listed may be subject to change and must be confirmed when ordering.

In order to promote constant updating of its products, Cariboni Group reserves the right to make changes without prior notice.