



### General Features

Description: LED floodlight

Insulation class: class II

Rated voltage: 220-240 V 50 Hz

Protection Grade: IP66

Impact protection: IK08

Power Factor: > 0.9

Ambient temperature  $T_a$ : -30°C +50°C

Weight: 2.00 kg

Max exposed surface: 0,027 m<sup>2</sup>

Lateral exposed surface: 0,027 m<sup>2</sup>

Driver: included

Marks and Certifications: CE

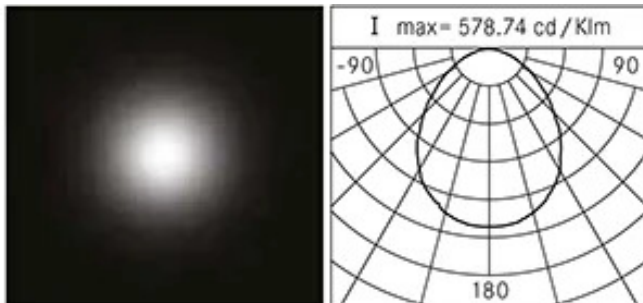
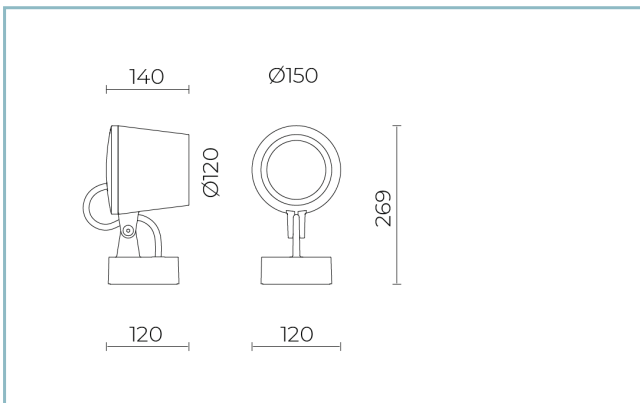

### Performance Data\*

LED Current:	500 mA
Source flux:	1730 lm
Source power:	17 W
Source efficiency:	102 lm/W
Device flux:	1210 lm
Device power:	20 W
Appliance efficiency:	61 lm/W
Glare Index Category:	D6

### Optical System

Source: CoB LED

Color Temperature: 2700 K

Color Rendering Index (CRI): ≥ 90

Chromatic consistency (SDCM): ≤ 3

Type of optics: U-D 90° Diffused beam

Optical group life: >60.000h @Ta25°C L80B10

Photobiological safety class: EXEMPT GROUP

ULOR: 0%

DLOR: 100%

Light intensity category: G\*6

### Normative References

EN60598-1 / EN60598-2-3 / EN62471 / EN61547

### Installation and maintenance

Installation: ceiling / wall / ground / pole side

Tilt: -90° +45°, continuously-adjustable pointing and locking system

Fixing: fixing base made of die-cast aluminium alloy UNI EN AB 47100 (copper content < 1%) for poles Ø 60-76mm

Wiring: pre-wired product with cable L=5m

Ø power cable: 9 ÷ 14 mm

Cable Gland: M29

Power supply compartment: independent from the optical group

### Flow adjustment

On request

DALI control

X

### Materials

Body: die-cast aluminium alloy UNI EN AB 47100 (copper content < 1%)

Screen: acid-etched glass

Lenses: highly transparent technopolymer lenses

Fixing system: die-cast aluminium alloy UNI EN AB 47100 (copper content < 1%)

Seals: expanded anti-age silicone foam

Screws: stainless steel AISI 304

Wiring plate: zinc-plated steel

Finish: phospho-chromatation treated and polyester powder-coated in 16 phases to increase weather resistance

### Colors

■ Sablé 100 Noir

Code: **06OM2A148B2C**

### Mandatory accessories



06KS918C0

B137 2 - way connector IP68

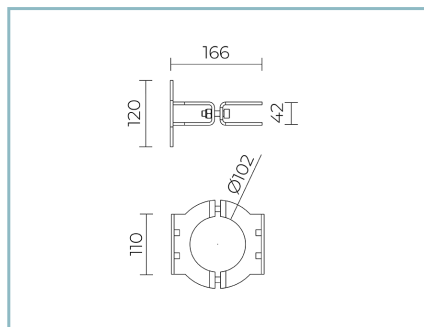

06OM904C0

B136 Single pole ring  
for  $\varnothing$  102 mm. Colour: Sablé 100 Noir.

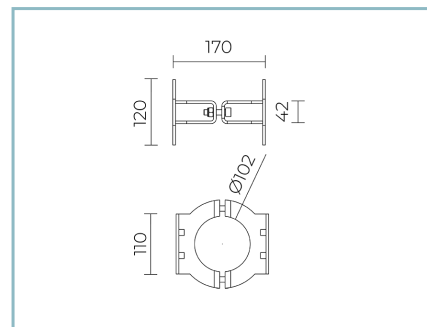

06OM905C0

B137 Double pole ring  
for  $\varnothing$  102 mm. Colour: Sablé 100 Noir.

### Optional accessories



06KS909C0

B89 Connector 4 way IP68

### NOTES

#### \*Performance data

The values indicated in this data sheet are nominal values with a tolerance of +/-7%.

Source flux and source efficiency data refer to the LED module without optics; in case you are interested in the performance of the LED module complete with optical system, you must multiply the data reported by the factor 0.9.

#### General Data

The characteristics of the product listed may be subject to change and must be confirmed when ordering.

In order to promote constant updating of its products, Cariboni Group reserves the right to make changes without prior notice.