



General Features

Description: LED luminaire

Insulation class: class II

Rated voltage: 220-240 V 50/60 Hz

Protection Grade: IP66

Impact protection: IK09

Surge protection device: integrated 10kV-10kA, Type 3, equipped with LED signaling and thermofusible for disconnection at the end of life; impulse withstand CL II 10kV DM

Power Factor: > 0.90

Ambient temperature Ta: -30°C +50°C

Weight: 7.50 kg

Max exposed surface: 0,2 m²

Lateral exposed surface: 0,04 m²

Common mode surge protection: 10 kV

Overtoltage protection differential mode: 10 kV

Driver: included

Driver lifetime: >100.000 h @ Ta 25°C (0,2% / 1000h)

Marks and Certifications: ENEC / CE



Performance Data*

Source flux:	5565 lm
Source power:	33.5 W
Source efficiency:	166 lm/W
Device flux:	4745 lm
Device power:	37 W
Appliance efficiency:	128 lm/W
Glare Index Category:	D3

Optical System

Source: LED R1
Color Temperature: 2700 K
Color Rendering Index (CRI): ≥ 70
Chromatic consistency (SDCM): ≤ 3
Type of optics: ST-02 Narrow street
Optical group life: >100.000 h @ Ta 25°C L90B10
Photobiological safety class: EXEMPT GROUP
ULOR: 0%
DLOR: 100%
Light intensity category: G*3
BUG rating: B1-U0-G1

Normative References

EN60598-1 / EN60598-2-3 / EN62471 / EN61547

Installation and maintenance

Installation: post top / side pole / arm / wall
Pole diameter: \varnothing 60 - 76 - 102 mm
Wiring: pre-wired product
\varnothing power cable: 10 ÷ 14 mm
Cable Gland: PG16
Replaceable wiring plate: removable plate
Replaceable optical unit: LED disc replacement
Power supply compartment: independent from the optical system

Flow adjustment

On request

Virtual Midnight Teaching	X
Arrangement for Zhaga connector (Book 18)	X
Constant flow output (CLO)	X
Adjusting 1-10V	X
DALI control	X
Mains voltage variation	X
Power line telemanagement (PLC)	X
Wireless remote management	X

Materials

Body: die-cast aluminium alloy UNI EN AB 47100 (copper content $< 1\%$)
Screen: tempered flat glass
Lenses: high-transparency PMMA
Fixing system: die-cast aluminium alloy UNI EN AB 47100 (copper content $< 1\%$)
Seals: expanded anti-age silicone foam
Screws: stainless steel AISI 304
Wiring plate: zinc-plated steel
Finish: phospho-chromatation treated and polyester powder-coated in 16 phases to increase weather resistance

Colors

■ Sablé 100 Noir	Code: 01ORIB272814CHM4
------------------	-------------------------------

Mandatory accessories



01OR901C0

B96 Post top joint
Ø 60 mm (H. 90 mm) for pole Ø 102 mm. Colour: Sablé 100 Noir.

Optional accessories



06KS909C0

B89 Connector 4 way IP68



01OR903C0

B98-P Wall-mounted arm
L=410 mm. Colour: Sablé 100 Noir.



01OR904C0

B99 Single rectangular arm
for poles Ø 102 mm. L=400 mm (S) / 470 mm (M). Colour: Sablé 100 Noir.

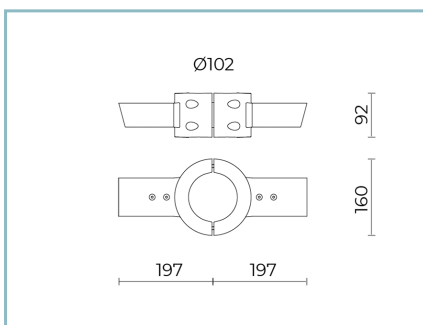

01OR905C0

B100 Double rectangular arm
for poles Ø 102 mm. L=400 mm (S) / 470 mm (M). Colour: Sablé 100 Noir.

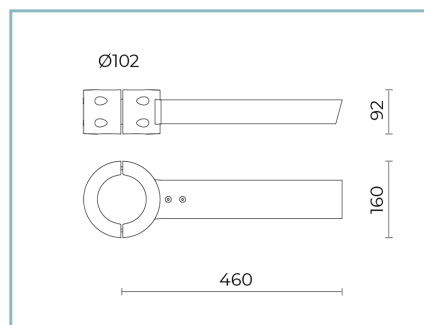

01OR906C0

B101 Single rectangular arm
for poles Ø 102 mm. L=670 mm (S) / 730 mm (M). Colour: Sablé 100 Noir.

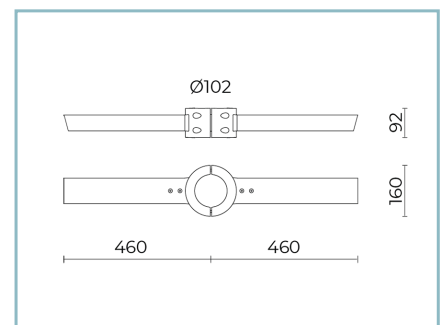

01OR907C0

B102 Double rectangular arm
for poles Ø 102 mm. L=670 mm (S) / 730 mm (M). Colour: Sablé 100 Noir.

Product Sheet

Rev. 24/06/2024

Orao Pole Side

Size: small

Color Temperature: 2700 K

Type of optics: ST-02 Narrow street

01OR1B272814CHM4

Colour: Sablé 100 Noir



01OR908C0

B103 Single rectangular arm for poles Ø 102 mm. L=950 mm (S) / 1015 mm (M). Colour: Sablé 100 Noir.



01OR909C0

B104 Double rectangular arm for poles Ø 102 mm. L=950 mm (S) / 1015 mm (M). Colour: Sablé 100 Noir.



01OR911C0

B106 Single tubular arm for poles Ø 60-76 mm. L=380 mm (S) / 445 mm (M). Colour: Sablé 100 Noir.



01OR912C0

B107 Double tubular arm for poles Ø 60-76 mm. L=380 mm (S) / 445 mm (M). Colour: Sablé 100 Noir.



01OR913C0

B108 Single tubular arm for poles Ø 60-76 mm. L=855 mm (S) / 920 mm (M). Colour: Sablé 100 Noir.



01OR914C0

B109 Double tubular arm for poles Ø 60-76 mm. L=855 mm (S) / 920 mm (M). Colour: Sablé 100 Noir.



01OR916C0

B83 Kit for suspension on curved arm. Colour: Sablé 100 Noir.

Product Sheet

Rev. 24/06/2024

Orao Pole Side

Size: small

Color Temperature: 2700 K

Type of optics: ST-02 Narrow street

01OR1B272814CHM4Colour: Sablé 100 Noir

NOTES***Performance data**

The values indicated in this data sheet are nominal values with a tolerance of +/-7%.

Source flux and source efficiency data refer to the LED module without optics; in case you are interested in the performance of the LED module complete with optical system, you must multiply the data reported by the factor 0.9.

General Data

The characteristics of the product listed may be subject to change and must be confirmed when ordering.

In order to promote constant updating of its products, Cariboni Group reserves the right to make changes without prior notice.