



General Features

Description: post top LED luminaire

Insulation class: class II

Rated voltage: 220-240 V 50/60 Hz

Protection Grade: IP66

Impact protection: IK09

Surge protection device: integrated 10kV-10kA, Type 3, equipped with LED signaling and thermofusible for disconnection at the end of life; impulse withstand CL II 10kV DM

Power Factor: > 0.90

Ambient temperature Ta: -30°C +50°C

Weight: 8.00 kg

Max exposed surface: 0,18 m²

Lateral exposed surface: 0,06 m²

Common mode surge protection: 10 kV

Overtoltage protection differential mode: 10 kV

Driver: included

Driver lifetime: >100.000 h @ Ta 25°C (0,2% / 1000h)

Marks and Certifications: ENEC / CE

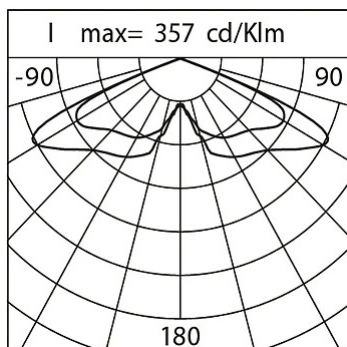
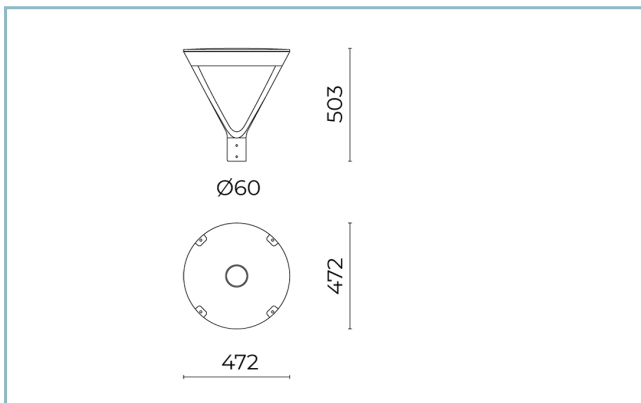

Performance Data*

Source flux:	2330 lm
Source power:	10.5 W
Source efficiency:	222 lm/W
Device flux:	1860 lm
Device power:	13 W
Appliance efficiency:	143 lm/W
Glare Index Category:	D6

Optical System

Source: LED R1
Color Temperature: 4000 K
Color Rendering Index (CRI): ≥ 70
Chromatic consistency (SDCM): ≤ 3
Type of optics: RS-02 Rotosymmetric Beam
Optical group life: >100.000 h @ Ta 25°C L90B10
Photobiological safety class: EXEMPT GROUP
ULOR: 0%
DLOR: 100%
Light intensity category: G*6
BUG rating: B1-U0-G1

Normative References

EN60598-1 / EN60598-2-3 / EN62471 / EN61547

Installation and maintenance

Installation: post top
Pole diameter: \varnothing 60 mm (76 mm with accessory)
Wiring: the product is supplied with an outgoing cable (L = 200 mm) and a 2-pin plug and socket connector for a quick and easy installation.
\varnothing power cable: 10 \div 14 mm
Cable Gland: PG16
Cable gland: M20
Replaceable wiring plate: removable by unlocking grubscrews
Replaceable optical unit: removable by unlocking grubscrews
Screen opening: opening by means of tools
Power supply compartment: independent from the optical system

Flow adjustment

On request

Virtual Midnight Teaching	X
Arrangement for Zhaga connector (Book 18)	X
Constant flow output (CLO)	X
Adjusting 1-10V	X
DALI control	X
Mains voltage variation	X
Wireless remote management	X
Provision for motion/light sensors	X

Materials

Body: die-cast aluminium alloy UNI EN AB 47100 (copper content < 1%)
Screen: tempered flat glass 5 mm
Lenses: high-transparency PMMA
Fixing system: die-cast aluminium alloy UNI EN AB 47100 (copper content < 1%)
Seals: expanded anti-age silicone foam
Screws: stainless steel AISI 304
Wiring plate: zinc-plated steel
Finish: phospho-chromatation treated and polyester powder-coated in 16 phases to increase weather resistance

Colors

■ Sablé 100 Noir	Code: 01PLB224024CHM4
------------------	------------------------------

Complements



01PL900C0

B183 Decorative upper cover
Colour: Sablé 100 Noir



01PL900U50

B 183 Decorative upper cover
Colour: GREEN YW354F



01PL900U60

B 183 Decorative upper cover
Colour: COPPER Y2304I



01AK980C0

B200 Pole adapter
Ø 76-80 mm top Ø60 mm. Colour:
Sablé 100 Noir.

NOTES

*Performance data

The values indicated in this data sheet are nominal values with a tolerance of +/-7%.

Source flux and source efficiency data refer to the LED module without optics; in case you are interested in the performance of the LED module complete with optical system, you must multiply the data reported by the factor 0.9.

General Data

The characteristics of the product listed may be subject to change and must be confirmed when ordering.

In order to promote constant updating of its products, Cariboni Group reserves the right to make changes without prior notice.