



General Features

Description: wall -mounted LED product

Insulation class: class III

Rated voltage: 15 V

Protection Grade: IP66

Impact protection: IK08

Power Factor: > 0.9

Ambient temperature Ta: -30°C +50°C

Weight: 2.00 kg

Driver: remote (to be ordered separately)

Marks and Certifications: CE

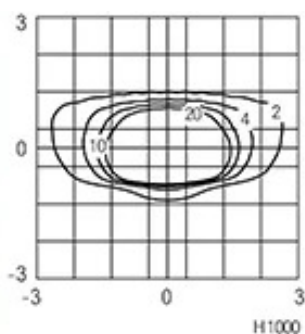

Performance Data*

LED Current:	500 mA
Source flux:	845 lm
Source power:	6.5 W
Source efficiency:	130 lm/W
Device flux:	250 lm
Device power:	6.5 W
Appliance efficiency:	38 lm/W
Glare Index Category:	D6

Optical System

Source: 8 LED

Color Temperature: 2700 K

Color Rendering Index (CRI): ≥ 80

Chromatic consistency (SDCM): ≤ 3

Type of optics: AS-D

Optical group life: $>60.000\text{h}$ @Ta25°C L80B10

Photobiological safety class: EXEMPT GROUP

Normative References

EN60598-1 / EN60598-2-3 / EN62471 / EN61547

Installation and maintenance

Installation: wall installation

Wiring: Rear cable entry

Flow adjustment

Standard

DALI control

X

Materials

Body: die-cast aluminium alloy UNI EN AB 47100 (copper content $< 1\%$)

Screen: polycarbonate

Optical Collimator: nylon PA66

Finish: phospho-chromatation treated and polyester powder-coated in 16 phases to increase weather resistance

Colors

■ Corten

Code: **06SS3A84847UV**

Mandatory accessories

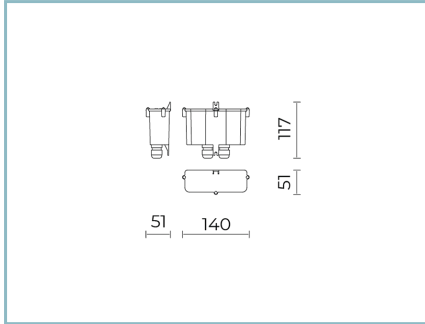

06SS902X0

B188 Driver Kit
B188 APLOS-S.SERIF DALI Driver Kit

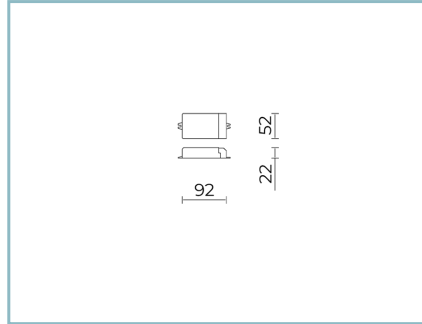

06LX900X0

B176 DALI driver 16W IP20

NOTES

*Performance data

The values indicated in this data sheet are nominal values with a tolerance of +/-7%.

Source flux and source efficiency data refer to the LED module without optics; in case you are interested in the performance of the LED module complete with optical system, you must multiply the data reported by the factor 0.9.

General Data

The characteristics of the product listed may be subject to change and must be confirmed when ordering.

In order to promote constant updating of its products, Cariboni Group reserves the right to make changes without prior notice.