

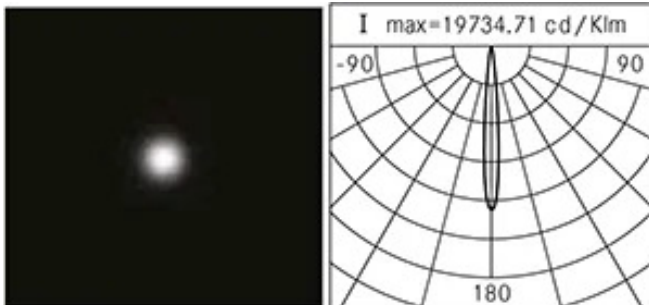

General Features

Description:	LED floodlight
Insulation class:	class II (class I on request)
Rated voltage:	220-240 V 50/60 Hz
Protection Grade:	IP66
Impact protection:	IK09
Power Factor:	> 0.90
Ambient temperature Ta:	-30°C +50°C
Weight:	9,1 kg
Max exposed surface:	0,13 m ²
Lateral exposed surface:	0,075 m ²
Common mode surge protection:	10 kV
Overvoltage protection differential mode:	6 kV
Driver:	included
Marks and Certifications:	ENEC / CE

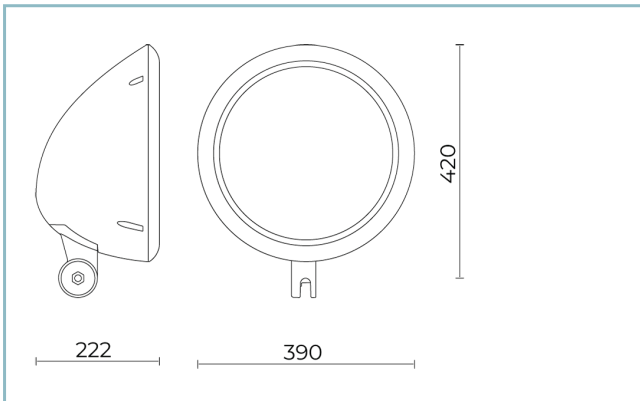

Performance Data*

LED Current:	700 mA
Source flux:	8395 lm
Source power:	65.5 W
Source efficiency:	128 lm/W
Device flux:	7215 lm
Device power:	71 W
Appliance efficiency:	102 lm/W
Glare Index Category:	D6

Optical System

Source: LED L8

Color Temperature: 2700 K

Color Rendering Index (CRI): ≥ 80

Chromatic consistency (SDCM): ≤ 3

Type of optics: C 11° Narrow beam

Optical group life: >100.000h @Ta25°C L80B10

Photobiological safety class: EXEMPT GROUP

ULOR: 0%

DLOR: 100%

Light intensity category: G*6

Normative References

EN60598-1 / EN60598-2-3 / EN62471 / EN61547

Installation and maintenance

Installation: wall / ceiling / ground / side pole / arm

Pole diameter: \varnothing 60 - 76 - 102 mm

Tilt: -90° +35°, continuously-adjustable pointing and locking system.

Fixing: fixing base made of die-cast aluminium alloy UNI EN AB 47100 (copper content < 1%), which can be rotated $\pm 30^\circ$

Wiring: pre-wired product

\varnothing power cable: 10 ÷ 14 mm

Cable Gland: PG16

Power supply compartment: independent from the optical group

Flow adjustment

Standard

DALI control

X

Materials

Body: die-cast aluminium alloy UNI EN AB 47100 (copper content < 1%)

Screen: tempered flat glass

Lenses: high-transparency PMMA

Fixing system: die-cast aluminium alloy UNI EN AB 47100 (copper content < 1%)

Seals: expanded anti-age silicone foam

Screws: stainless steel AISI 304

Wiring plate: zinc-plated steel

Finish: phospho-chromatation treated and polyester powder-coated in 16 phases to increase weather resistance

Colors

■ Sablé 100 Noir

Code: **06SG4D208B8CHL**

Mandatory accessories



06SG903C0

B127 Adjustable joint which can be rotated $\pm 30^\circ$ and tilted - $90^\circ + 35^\circ$. Colour: Sablé 100 Noir.



06SG904C0

B128 Adjustable joint for ring and arm $\varnothing 60$ mm and for picket. Colour: Sablé 100 Noir.

Optional accessories



06LT908C0

B117 Picket for ground installation LIT/SIGMA 1x $\varnothing 60$ x542. Colour: Sablé 100 Noir.



06LT909J0

B118 Anchor for concrete L=200 mm.



06KS909C0

B89 Connector 4 way IP68

NOTES

*Performance data

The values indicated in this data sheet are nominal values with a tolerance of $\pm 7\%$.

Source flux and source efficiency data refer to the LED module without optics; in case you are interested in the performance of the LED module complete with optical system, you must multiply the data reported by the factor 0.9.

General Data

The characteristics of the product listed may be subject to change and must be confirmed when ordering.

In order to promote constant updating of its products, Cariboni Group reserves the right to make changes without prior notice.