

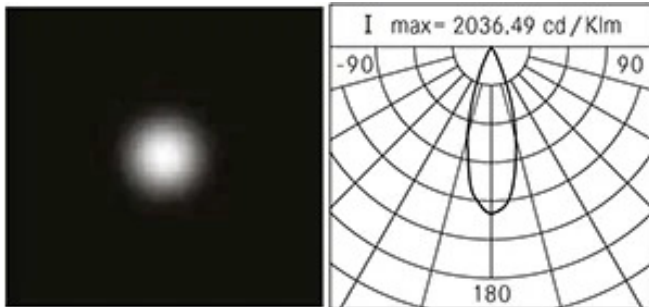

### General Features

Description:	LED floodlight
Insulation class:	class II (class I on request)
Rated voltage:	220-240 V 50/60 Hz
Protection Grade:	IP66
Impact protection:	IK09
Power Factor:	> 0.90
Ambient temperature Ta:	-30°C +50°C
Weight:	9,1 kg
Max exposed surface:	0,13 m <sup>2</sup>
Lateral exposed surface:	0,075 m <sup>2</sup>
Common mode surge protection:	10 kV
Overvoltage protection differential mode:	6 kV
Driver:	included
Marks and Certifications:	ENEC / CE

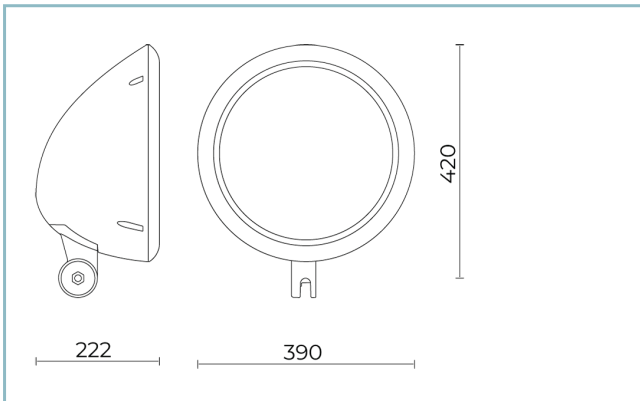

### Performance Data\*

LED Current:	350 mA
Source flux:	4610 lm
Source power:	31.5 W
Source efficiency:	146 lm/W
Device flux:	3965 lm
Device power:	35.5 W
Appliance efficiency:	112 lm/W
Glare Index Category:	D6

### Optical System

Source: LED L8

Color Temperature: 2700 K

Color Rendering Index (CRI):  $\geq 80$

Chromatic consistency (SDCM):  $\leq 3$

Type of optics: D 40° Wide beam

Optical group life: >100.000h @Ta25°C L80B10

Photobiological safety class: EXEMPT GROUP

ULOR: 0%

DLOR: 100%

Light intensity category: G\*6

### Normative References

EN60598-1 / EN60598-2-3 / EN62471 / EN61547

### Installation and maintenance

Installation: wall / ceiling / ground / side pole / arm

Pole diameter:  $\varnothing$  60 - 76 - 102 mm

Tilt: -90° +35°, continuously-adjustable pointing and locking system.

Fixing: upwards installation on a pole arm (for poles  $\varnothing$  60-76 mm or poles  $\varnothing$  102 mm) with adjustable joint made of die-cast aluminium alloy UNI EN AB 47100 (copper content < 1%), polyester powder coated (Sablé 100 Noir);

Wiring: pre-wired product

$\varnothing$  power cable: 10 ÷ 14 mm

Cable Gland: PG16

Power supply compartment: independent from the optical group

### Flow adjustment

Standard

DALI control

X

### Materials

Body: die-cast aluminium alloy UNI EN AB 47100 (copper content < 1%)

Screen: tempered flat glass

Lenses: high-transparency PMMA

Fixing system: die-cast aluminium alloy UNI EN AB 47100 (copper content < 1%)

Seals: expanded anti-age silicone foam

Screws: stainless steel AISI 304

Wiring plate: zinc-plated steel

Finish: phospho-chromatation treated and polyester powder-coated in 16 phases to increase weather resistance

### Colors

■ Sablé 100 Noir

Code: **06SG4D238C0CHL**

### Mandatory accessories



06SG904C0

B128 Adjustable joint  
for ring and arm Ø 60mm and for  
picket. Colour: Sablé 100 Noir.

### Optional accessories



06AK916C0

B139 Single ring Ø102mm.  
Colour: Sablé 100 Noir.



06AK917C0

B140 Double ring for pole Ø102mm.  
Colour: Sablé 100 Noir.



01AK903C0

L3 Single joint kit  
for Ø 60-76 mm pole. Colour: Sablé 100  
Noir.



01AK904C0

L4 Double joint kit  
for Ø 60-76 mm pole. Colour: Sablé 100  
Noir.



01AK921C0

B1 Single tubular arm  
Ø 60 mm for poles Ø 60-76 mm. L=550  
mm. Colour: Sablé 100 Noir.



01AK922C0

B2 Double tubular arm  
Ø 60 mm for poles Ø 60-76 mm. L=550  
mm. Colour: Sablé 100 Noir.



06AK907C0

B155 Single arm  
for poles Ø 102 mm. L=550 mm. Colour:  
Sablé 100 Noir.



06AK909C0

B157 Double arm  
for poles Ø 102 mm. L=550 mm. Colour:  
Sablé 100 Noir.

#### NOTES

##### \*Performance data

The values indicated in this data sheet are nominal values with a tolerance of +/-7%.

Source flux and source efficiency data refer to the LED module without optics; in case you are interested in the performance of the LED module complete with optical system, you must multiply the data reported by the factor 0.9.

##### General Data

The characteristics of the product listed may be subject to change and must be confirmed when ordering.

In order to promote constant updating of its products, Cariboni Group reserves the right to make changes without prior notice.