



General Features

Description: LED luminaire

Insulation class: class II

Rated voltage: 220-240 V 50/60 Hz

Protection Grade: IP66

Impact protection: IK09

Surge protection device: integrated 10kV-10kA, Type 3, equipped with LED signaling and thermofusible for disconnection at the end of life; impulse withstand CL II 10kV DM

Power Factor: > 0.90

Ambient temperature Ta: -30°C +50°C

Weight: 8.00 kg

Max exposed surface: 0,13 m²

Lateral exposed surface: 0,075 m²

Common mode surge protection: 10 kV

Overtoltage protection differential mode: 10 kV

Driver: included

Driver lifetime: >100.000 h @ Ta 25°C (0,2% / 1000h)

Marks and Certifications: CE

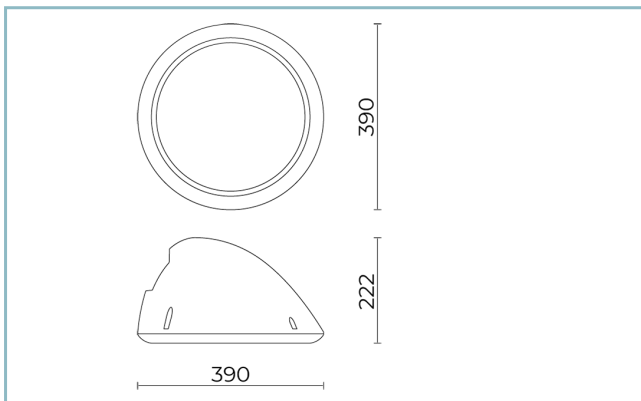

Performance Data*

Source flux:	9345 lm
Source power:	49 W
Source efficiency:	190 lm/W
Device flux:	8040 lm
Device power:	53 W
Appliance efficiency:	151 lm/W
Glare Index Category:	D4

Optical System

Source: LED R2
Color Temperature: 3000 K
Color Rendering Index (CRI): ≥ 70
Chromatic consistency (SDCM): ≤ 3
Type of optics: LA-03 Wide street
Optical group life: >100.000 h @ Ta 25°C L90B10
Photobiological safety class: EXEMPT GROUP
ULOR: 0%
DLOR: 100%
Light intensity category: G*3
BUG rating: B1-U0-G2

Normative References

EN60598-1 / EN60598-2-3 / EN62471 / EN61547

Installation and maintenance

Installation: post top / side pole / wall
Pole diameter: \varnothing 60 - 76 - 102 mm
Tilt: (pole side, wall, ground) -90° $+35^{\circ}$
Fixing: the product can be equipped with a fixing base for wall mounting, an adjustable joint for installation on arm and pole or with the new post top accessory.
Wiring: the product is supplied with an outgoing cable (L = 0,2m) and a 4-pin plug and socket connector for a quick and easy installation.
\varnothing power cable: 10 ÷ 14 mm
Cable Gland: PG16
Replaceable wiring plate: removable plate
Replaceable optical unit: each LED module is replaceable
Screen opening: opening by means of tools
Power supply compartment: independent from the optical group

Flow adjustment

	On request
Virtual Midnight Teaching	X
Constant flow output (CLO)	X
Adjusting 1-10V	X
DALI control	X
Mains voltage variation	X
Power line telemanagement (PLC)	X
Wireless remote management	X
Provision for motion/light sensors	X

Materials

Body: die-cast aluminium alloy UNI EN AB 47100 (copper content $< 1\%$)
Screen: tempered flat glass
Lenses: high-transparency PMMA
Fixing system: die-cast aluminium alloy UNI EN AB 47100 (copper content $< 1\%$)
Seals: expanded anti-age silicone foam
Screws: stainless steel AISI 304
Wiring plate: zinc-plated steel
Finish: phospho-chromatation treated and polyester powder-coated in 16 phases to increase weather resistance

Colors

■ Sablé 100 Noir	Code: 06SG4C454917CHM4
------------------	-------------------------------

Mandatory accessories



06SG905C0

B178 Kit post top
Ø 60 mm (H. 90 mm) for pole Ø
76mm. Colour: Sablé 100 Noir.



06SG906C0

B179 Kit pole side
Ø60-76mm SIGMA STREET SMALL.
Colour: Sablé 100 Noir.



06SG907C0

B180 Kit pole side
Ø60-76mm SIGMA STREET MEDIUM.
Colour: Sablé 100 Noir.



06SG908C0

B181 Adjustable joint
for wall or ground SIGMA STREET
SMALL. Colour: Sablé 100 Noir.



06SG909C0

B182 Adjustable joint
for wall or ground SIGMA STREET
MEDIUM. Colour: Sablé 100 Noir.

Optional accessories



06AK916C0

B139 Single ring Ø102mm.
Colour: Sablé 100 Noir.



06AK917C0

B140 Double ring for pole Ø102mm.
Colour: Sablé 100 Noir.



01AK903C0

L3 Single joint kit
for Ø 60-76 mm pole. Colour: Sablé 100
Noir.



01AK904C0

L4 Double joint kit
for Ø 60-76 mm pole. Colour: Sablé 100
Noir.



01AK921C0

B1 Single tubular arm
Ø 60 mm for poles Ø 60-76 mm. L=550
mm. Colour: Sablé 100 Noir.



01AK922C0

B2 Double tubular arm
Ø 60 mm for poles Ø 60-76 mm. L=550
mm. Colour: Sablé 100 Noir.



06AK907C0

B155 Single arm
for poles Ø 102 mm. L=550 mm. Colour:
Sablé 100 Noir.



06AK909C0

B157 Double arm
for poles Ø 102 mm. L=550 mm. Colour:
Sablé 100 Noir.

NOTES

*Performance data

The values indicated in this data sheet are nominal values with a tolerance of +/-7%.

Source flux and source efficiency data refer to the LED module without optics; in case you are interested in the performance of the LED module complete with optical system, you must multiply the data reported by the factor 0.9.

General Data

The characteristics of the product listed may be subject to change and must be confirmed when ordering.

In order to promote constant updating of its products, Cariboni Group reserves the right to make changes without prior notice.