



General Features

Description: LED fitting for lighting façades, paths and urban spaces

Insulation class: class II

Rated voltage: 220-240 V 50/60 Hz

Protection Grade: IP66

Impact protection: IK09

Power Factor: > 0.9

Ambient temperature Ta: -25° C + 50° C

Weight: 7.5 kg

Max exposed surface: 0.157 m²

Lateral exposed surface: 0.063 m²

Common mode surge protection: 10 kV

Overvoltage protection differential mode: 10 kV

Driver: included

Driver lifetime: > 100.000 h @Ta 25° C

Marks and Certifications: CE / ENEC

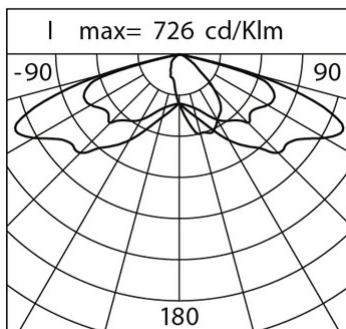
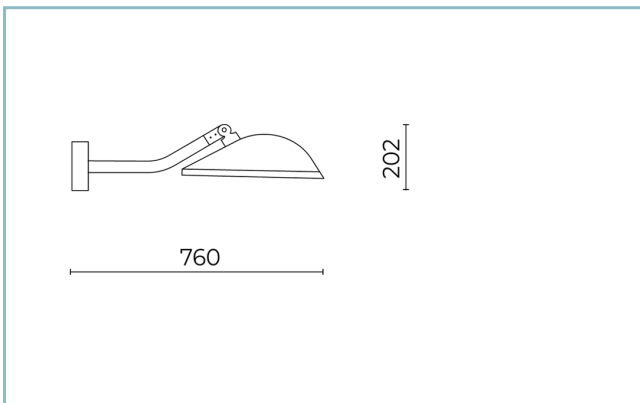

Performance Data*

Source flux:	8700 lm
Source power:	49 W
Source efficiency:	178 lm/W
Device flux:	7300 lm
Device power:	53 W
Appliance efficiency:	138 lm/W
Glare Index Category:	D4

Optical System

Source: LED R2

Color Temperature: 3000 K

Color Rendering Index (CRI): ≥ 80

Chromatic consistency (SDCM): ≤ 3

Type of optics: ST-02 Narrow street

Optical group life: > 100.000 h @ 720mA @Ta 25° C TM21 L90B10

Photobiological safety class: EXEMPT GROUP

ULOR: 0%

DLOR: 100%

Light intensity category: G*3

BUG rating: B2-U0-G1

Normative References

EN60598-1 / EN60598-2-3 / IEC / TR62778 / EN62471 / EN61547

Installation and maintenance

Installation: wall

Tilt: $0^\circ \div 90^\circ$

\varnothing power cable: $6 \div 11$ mm

Cable Gland: PG13,5

Power supply compartment: independent from the optical group

Flow adjustment

Standard On request

Virtual Midnight Teaching X

Arrangement for Zhaga connector (Book 18) X

DALI control X

Materials

Body: die-cast aluminium alloy UNI EN AB 47100 (copper content $< 1\%$)

Screen: tempered flat glass

Lenses: high-transparency PMMA

Fixing system: die-cast aluminium alloy UNI EN AB 47100 (copper content $< 1\%$)

Seals: anti-age silicone foam

Screws: stainless steel AISI 304

Wiring plate: zinc-plated steel

Finish: phospho-chromatation treated and polyester powder-coated in 16 phases to increase weather resistance

Colors

■ Champagne

Code: **06SP2BC454914G6HL**

Product Sheet

Rev 16/07/2024

Spoon Wall

Size: large

Color Temperature: 3000 K

Type of optics: ST-02 Narrow street

06SP2BC454914G6HLColour: Champagne

NOTES***Performance data**

The values indicated in this data sheet are nominal values with a tolerance of +/-7%.

Source flux and source efficiency data refer to the LED module without optics; in case you are interested in the performance of the LED module complete with optical system, you must multiply the data reported by the factor 0.9.

General Data

The characteristics of the product listed may be subject to change and must be confirmed when ordering.

In order to promote constant updating of its products, Cariboni Group reserves the right to make changes without prior notice.