

General Features

Description: LED product for linear outdoor and indoor lighting

Insulation class: classe II

Rated voltage: 230 V

Protection Grade: IP67

Impact protection: IK08

Power Factor: > 0.90

Ambient temperature Ta: -10°C +45°C

Weight: 22.00 kg

Driver: included

Marks and Certifications: CE

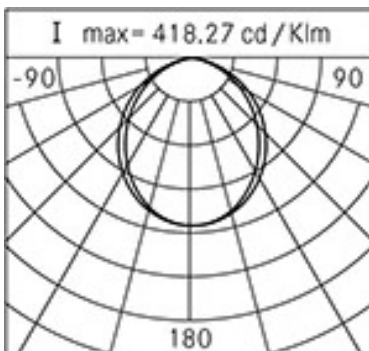
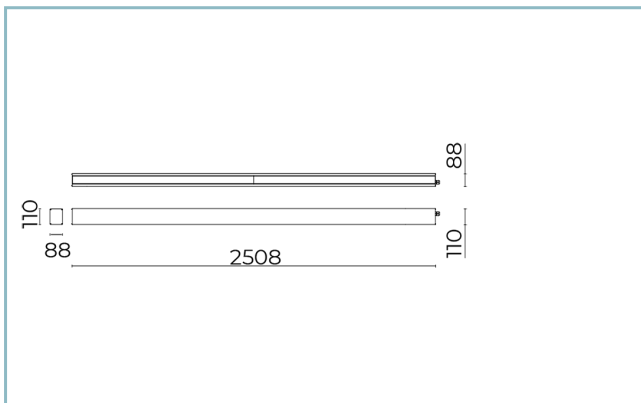

Performance Data*

Source flux:	5130 lm
Source power:	29 W
Source efficiency:	177 lm/W
Device flux:	3030 lm
Device power:	29 W
Appliance efficiency:	104 lm/W
Glare Index Category:	D6

Optical System

Source: LED

Color Temperature: 3000 K

Color Rendering Index (CRI): ≥ 80

Chromatic consistency (SDCM): ≤ 3

Type of optics: ultra-diffondente 80°/100°

Optical group life: >60.000h @Ta25°C L80B10

Light intensity category: G*6

Normative References

EN60598-1 / EN60598-2-1 / EN60598-2-2 / EN62471

Installation and maintenance

Installation: ceiling installation

Fixing: Extruded fastening jig length 2500 mm

Wiring: pre-wiring with cable L=1500 mm

Ø power cable: cavo bipolare 2x0,5 mm² e relativo
connettore (incluso)

Flow adjustment

On request

DALI control

X

Materials

Body: extrusion and further anodization

Diffuser: transparent flat glass

Lenses: highly transparent technopolymer lenses

Fixing system: closing heads and fastening accessories
made of die-cast aluminium alloy UNI EN AB 47100
(copper content < 1%)

Seals: extruded anti-age silicone

Screws: stainless steel AISI 304

Colors

■ natural anodized
aluminium

Code: **06TR6Q4393JA7**

Mandatory accessories

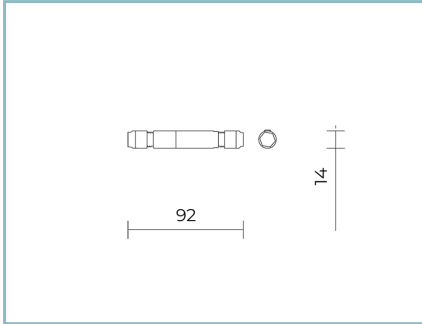

06GC902X0

B165 2-pole connector IP68

Optional accessories

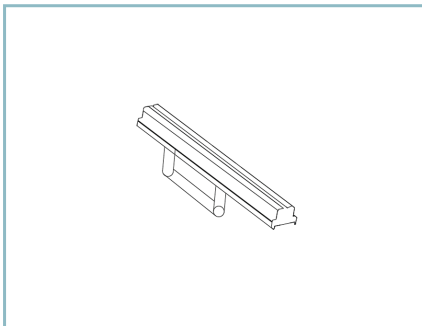

06TR980J0

Extruded fastening jig

NOTES

*Performance data

The values indicated in this data sheet are nominal values with a tolerance of +/-7%.

Source flux and source efficiency data refer to the LED module without optics; in case you are interested in the performance of the LED module complete with optical system, you must multiply the data reported by the factor 0.9.

General Data

The characteristics of the product listed may be subject to change and must be confirmed when ordering.

In order to promote constant updating of its products, Cariboni Group reserves the right to make changes without prior notice.