

General Features

Description: ceiling / wall / ground-mounted LED product

Insulation class: class III

Rated voltage: 24Vdc

Protection Grade: IP67

Impact protection: IK08

Power Factor: > 0.90

Ambient temperature T_a : -10°C $+45^\circ\text{C}$

Weight: 3.00 kg

Driver: remote (to be ordered separately)

Marks and Certifications: ENEC / CE

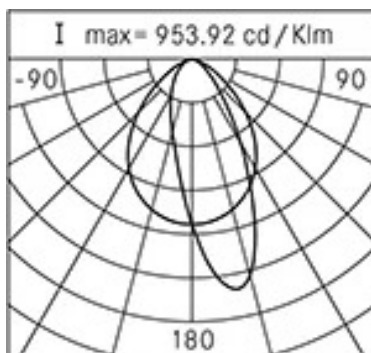
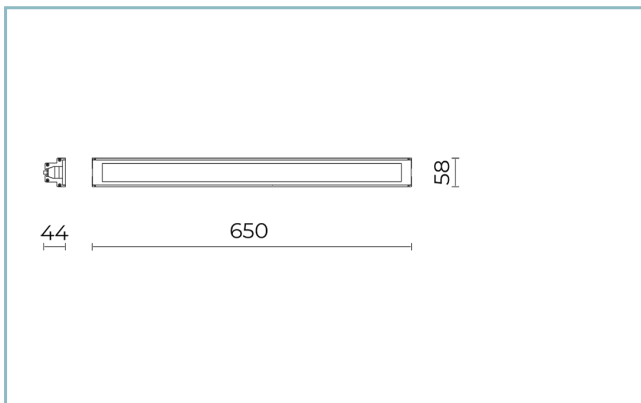

Performance Data*

Source flux:	1285 lm
Source power:	7.2 W
Source efficiency:	178 lm/W
Device flux:	925 lm
Device power:	7.2 W
Appliance efficiency:	128 lm/W
Glare Index Category:	D6

Optical System

Source: LED

Color Temperature: 3000 K

Color Rendering Index (CRI): ≥ 80

Chromatic consistency (SDCM): ≤ 3

Type of optics: asimmetrica $\alpha=13^\circ 30'/75^\circ$

Optical group life: $>60.000h @Ta25^\circ C L80B10$

Light intensity category: G*6

Normative References

EN60598-1 / EN60598-2-1 / EN60598-2-2 / EN62471

Installation and maintenance

Installation: ceiling / wall / ground (outside or recessed)

Fixing: recessed housing (wall / ground recessed);
adjustable brackets / junction box / junction box with
adjustable brackets / ceiling-mounted bracket /
suspension kit (for outdoor installation)

Wiring: pre-wiring with cable L=1500 mm

\varnothing power cable: cavo bipolare 2x0,5 mm² e relativo
connettore (incluso)

Flow adjustment

On request

Adjusting 1-10V

X

DALI control

X

Materials

Body: extrusion and further anodization

Diffuser: transparent flat glass (walkable version up to 1000
kg)

Lenses: highly transparent technopolymer lenses

Fixing system: closing heads and fastening accessories
made of die-cast aluminium alloy UNI EN AB 47100
(copper content $< 1\%$)

Seals: extruded anti-age silicone

Screws: stainless steel AISI 304

Colors

■ natural anodized
aluminium

Code: **06TR2D6397J**

Mandatory accessories



06LL915AB0
Driver
240W-24V IP67

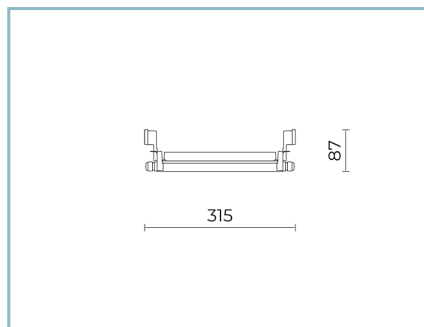

06OT988A0
Wired box TRAIL 650
for wall or ceiling attachment IP65.
Colour: grey RAL9006.



06OT989A0
Wired box TRAIL 1250
for wall or ceiling attachment IP65.
Colour: grey RAL9006.



06TA902X0
Driver
60W-24V IP66

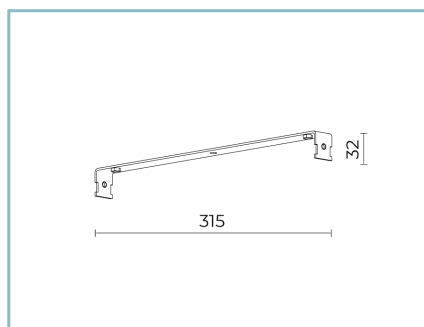

06TR987A0
Ceiling fixing bracket.
Colour: grey RAL9006.

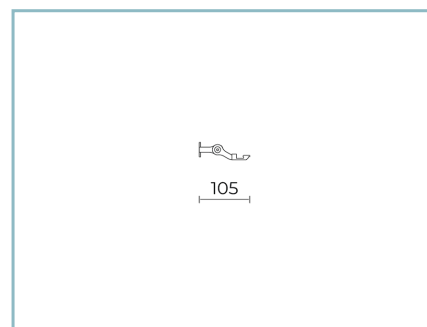

06TR997A0
Wall-mounted fixing brackets kit.
Colour: grey RAL9006.

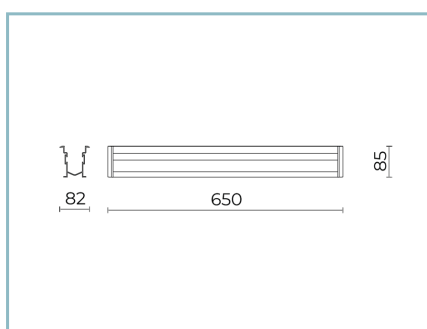

06TR998J0
Recessed housing
for ground recessed and wall
installation, with IP68 connector

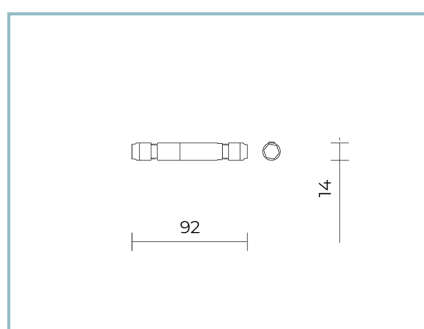

06GC902X0
B165 2-pole connector IP68

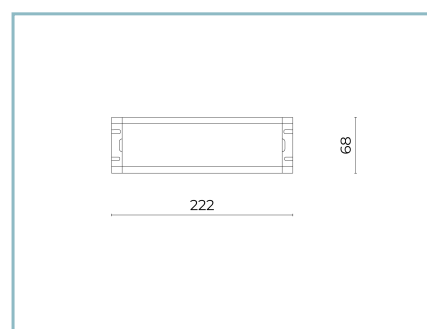

06LL914AB0
DALI driver
150W-24V IP67

Product Sheet

Rev. 17/01/2023

Trail Wall-Recessed

Size: L. 650mm

Color Temperature: 3000 K

Type of optics: asimmetrica $\alpha=13^\circ 30'/75^\circ$ **06TR2D6397J**Colour: natural anodized
aluminium

NOTES***Performance data**

The values indicated in this data sheet are nominal values with a tolerance of +/-7%.

Source flux and source efficiency data refer to the LED module without optics; in case you are interested in the performance of the LED module complete with optical system, you must multiply the data reported by the factor 0.9.

General Data

The characteristics of the product listed may be subject to change and must be confirmed when ordering.

In order to promote constant updating of its products, Cariboni Group reserves the right to make changes without prior notice.