

### General Features

Description: ceiling / wall / ground-mounted LED product

Insulation class: class III

Rated voltage: 24Vdc

Protection Grade: IP67

Impact protection: IK08

Power Factor: > 0.90

Ambient temperature Ta: -10°C +45°C

Weight: 3.00 kg

Driver: remote (to be ordered separately)

Marks and Certifications: ENEC / CE



### Performance Data\*

Source flux:	2480 lm
Source power:	14.5 W
Source efficiency:	171 lm/W
Device flux:	1540 lm
Device power:	14.5 W
Appliance efficiency:	106 lm/W
Glare Index Category:	D6

### Optical System

Source: LED

Color Temperature: 3000 K

Color Rendering Index (CRI):  $\geq 80$

Chromatic consistency (SDCM):  $\leq 3$

Type of optics: simmetrica 75°/95°

Optical group life: >60.000h @Ta25°C L80B10

Light intensity category: G\*6

### Normative References

EN60598-1 / EN60598-2-1 / EN60598-2-2 / EN62471

### Installation and maintenance

Installation: ceiling / wall / ground (outside or recessed)

Fixing: recessed housing (wall / ground recessed);  
adjustable brackets / junction box / junction box with  
adjustable brackets / ceiling-mounted bracket /  
suspension kit (for outdoor installation)

Wiring: pre-wiring with cable L=1500 mm

Ø power cable: cavo bipolare 2x0,5 mm<sup>2</sup> e relativo  
connettore (incluso)

### Flow adjustment

On request

Adjusting 1-10V

X

DALI control

X

### Materials

Body: extrusion and further anodization

Diffuser: transparent flat glass (walkable version up to 1000  
kg)

Lenses: highly transparent technopolymer lenses

Fixing system: closing heads and fastening accessories  
made of die-cast aluminium alloy UNI EN AB 47100  
(copper content < 1%)

Seals: extruded anti-age silicone

Screws: stainless steel AISI 304

### Colors

■ natural anodized  
aluminium

Code: **06TR2H2395J**

**Mandatory accessories**



06LL915AB0  
Driver  
240W-24V IP67

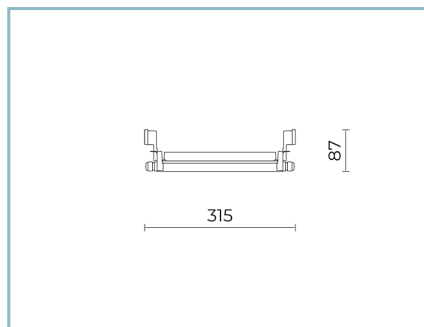

06OT988A0  
Wired box TRAIL 650  
for wall or ceiling attachment IP65.  
Colour: grey RAL9006.



06OT989A0  
Wired box TRAIL 1250  
for wall or ceiling attachment IP65.  
Colour: grey RAL9006.



06TA902X0  
Driver  
60W-24V IP66

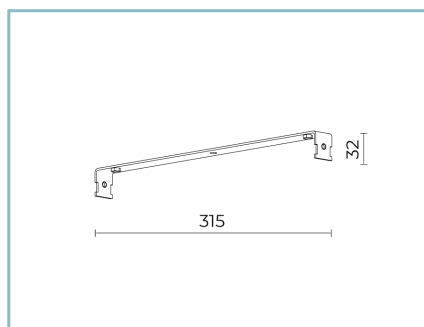

06TR987A0  
Ceiling fixing bracket.  
Colour: grey RAL9006.

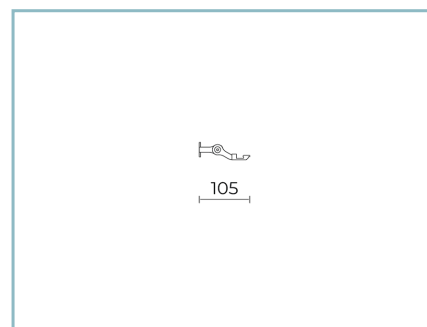

06TR997A0  
Wall-mounted fixing brackets kit.  
Colour: grey RAL9006.

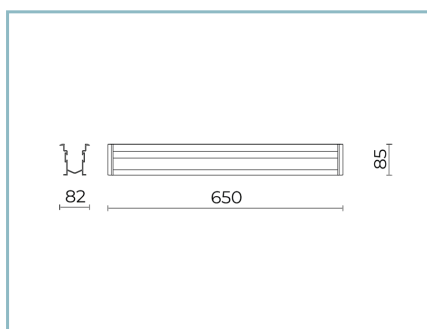

06TR998J0  
Recessed housing  
for ground recessed and wall  
installation, with IP68 connector

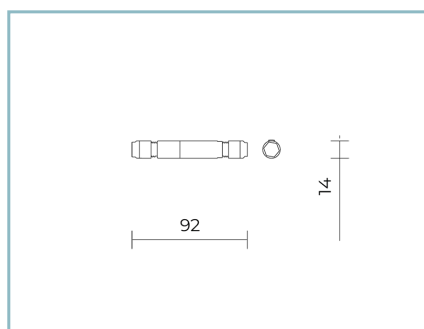

06GC902X0  
B165 2-pole connector IP68

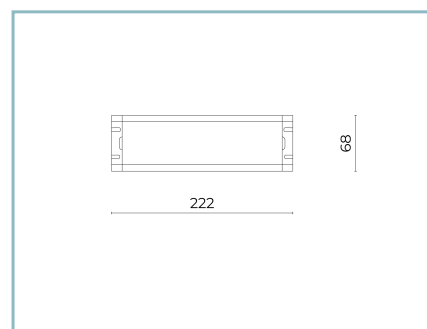

06LL914AB0  
DALI driver  
150W-24V IP67

---

**Product Sheet**

Rev. 17/01/2023

**Trail Wall-Recessed**

Size: L. 650mm

Color Temperature: 3000 K

Type of optics: simmetrica 75°/95°

**06TR2H2395J**Colour: natural anodized  
aluminium

---

---

**NOTES****\*Performance data**

The values indicated in this data sheet are nominal values with a tolerance of +/-7%.

Source flux and source efficiency data refer to the LED module without optics; in case you are interested in the performance of the LED module complete with optical system, you must multiply the data reported by the factor 0.9.

**General Data**

The characteristics of the product listed may be subject to change and must be confirmed when ordering.

In order to promote constant updating of its products, Cariboni Group reserves the right to make changes without prior notice.