



General Features

Description:	LED luminaire
Insulation class:	class II
Rated voltage:	220-240 V 50/60 Hz
Protection Grade:	IP66
Impact protection:	IK09
Surge protection device:	integrated 10kV-10kA, Type 3, equipped with LED signaling and thermofusible for disconnection at the end of life; impulse withstand CL II 10kV DM
Power Factor:	> 0.90
Ambient temperature Ta:	-30°C +50°C
Weight:	12 kg
Max exposed surface:	0.28 m ²
Lateral exposed surface:	0.09 m ²
Common mode surge protection:	10 kV
Overtoltage protection differential mode:	10 kV
Driver:	included
Driver lifetime:	>100.000 h @ Ta 25°C (0,2% / 1000h)
Marks and Certifications:	ENEC / CE

Performance Data*

Source flux:	18135 lm
Source power:	109.5 W
Source efficiency:	166 lm/W
Device flux:	15455 lm
Device power:	119 W
Appliance efficiency:	130 lm/W
Glare Index Category:	D3

Optical System

Source: LED R4
Color Temperature: 2700 K
Color Rendering Index (CRI): ≥ 70
Chromatic consistency (SDCM): ≤ 3
Type of optics: LA-03 Wide street
Optical group life: >100.000 h @ Ta 25°C L90B10
Photobiological safety class: EXEMPT GROUP
ULOR: 0%
DLOR: 100%
Light intensity category: G*3
BUG rating: B2-U0-G2

Normative References

EN60598-1 / EN60598-2-3 / EN61547 / EN62471, EN55015 / EN61000-3-2 / EN61000-3-3

Installation and maintenance

Installation: side pole / arm / wall
Pole diameter: \varnothing 60 - 76 - 102 mm
\varnothing power cable: 10 ÷ 14 mm
Cable Gland: PG16
Replaceable wiring plate: removable plate
Replaceable optical unit: each LED module is replaceable
Screen opening: opening by clip, fall block
Disconnecter: automatic (with terminal section 2.5 mm ²)
Power supply compartment: independent from the optical system

Flow adjustment

On request

Virtual Midnight Teaching	X
Arrangement for Zhaga connector (Book 18)	X
Constant flow output (CLO)	X
Adjusting 1-10V	X
DALI control	X
Mains voltage variation	X
Power line telemanagement (PLC)	X
Wireless remote management	X
Provision for motion/light sensors	X

Materials

Body: die-cast aluminium alloy UNI EN AB 47100 (copper content $< 1\%$)
Screen: tempered flat glass
Lenses: high-transparency PMMA
Fixing system: die-cast aluminium alloy UNI EN AB 47100 (copper content $< 1\%$)
Seals: expanded anti-age silicone foam
Screws: stainless steel AISI 304
Wiring plate: zinc-plated steel
Finish: phospho-chromatation treated and polyester powder-coated in 16 phases to increase weather resistance

Colors

■ Sablé 100 Noir	Code: 01VO4E860817CHM4
------------------	-------------------------------

Mandatory accessories



01VO901C0

L17 Fixed side kit
for $\varnothing 48$ -60 mm arm. Colour: Sablé 100
Noir.



01VO902C0

L16 Adjustable side kit
for $\varnothing 60$ mm pole or arm. Colour: Sablé
100 Noir.

Optional accessories



01VO904C0

B204 Joint kit
for $\varnothing 60$ -76 mm pole. Colour: Sablé 100
Noir.



01VO905C0

B205 Double joint kit
for $\varnothing 60$ -76 mm pole. Colour: Sablé 100
Noir.



06AK905C0

B153 Post top joint
 $\varnothing 60$ mm (h. 90 mm). Colour: Sablé 100
Noir.



01AK984C0

B208 Single arm
for poles $\varnothing 60$ -76 mm. Colour: Sablé
100 Noir.



01AK985C0

B209 Double arm
for poles $\varnothing 60$ -76 mm. Colour: Sablé
100 Noir.



01AK986C0

B210 Single arm
for poles $\varnothing 102$ mm. Colour: Sablé 100
Noir.

Product Sheet

Rev 24/05/2024

Volta Pole SideSize: medium
Color Temperature: 2700 K
Type of optics: LA-03 Wide street**01VO4E860817CHM4**

Colour: Sablé 100 Noir

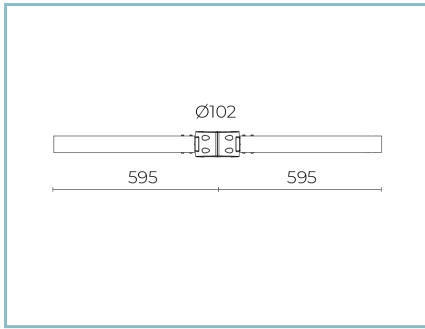
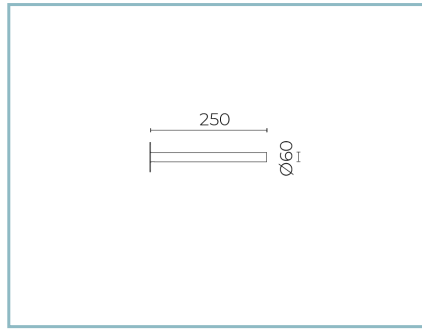
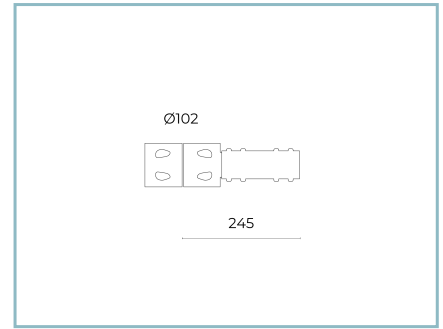
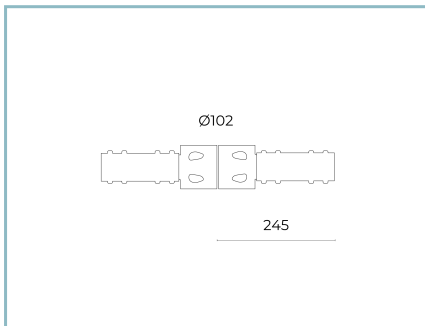
**01AK987C0**B211 Double arm
for poles $\varnothing 102$ mm. Colour: Sablé 100
Noir.**01AK982C0**B206-P Side wall-mounted arm.
Colour: Sablé 100 Noir.**06AK906C0**B154 Single arm
for poles $\varnothing 102$ mm. L=245 mm. Colour:
Sablé 100 Noir.**06AK908C0**B156 Double arm
for poles $\varnothing 102$ mm. L=245 mm. Colour:
Sablé 100 Noir.**NOTES*****Performance data**

The values indicated in this data sheet are nominal values with a tolerance of +/-7%.

Source flux and source efficiency data refer to the LED module without optics; in case you are interested in the performance of the LED module complete with optical system, you must multiply the data reported by the factor 0.9.

General Data

The characteristics of the product listed may be subject to change and must be confirmed when ordering.

In order to promote constant updating of its products, Cariboni Group reserves the right to make changes without prior notice.