



General Features

Description: LED luminaire

Insulation class: class II

Rated voltage: 220-240 V 50/60 Hz

Protection Grade: IP66

Impact protection: IK09

Surge protection device: integrated 10kV-10kA, Type 3, equipped with LED signaling and thermofusible for disconnection at the end of life; impulse withstand CL II 10kV DM

Power Factor: > 0.90

Ambient temperature Ta: -30°C +50°C

Weight: 12 kg

Max exposed surface: 0.28 m²

Lateral exposed surface: 0.09 m²

Common mode surge protection: 10 kV

Overtoltage protection differential mode: 10 kV

Driver: included

Driver lifetime: >100.000 h @ Ta 25°C (0,2% / 1000h)

Marks and Certifications: ENEC / CE

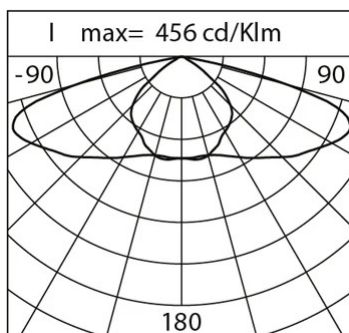
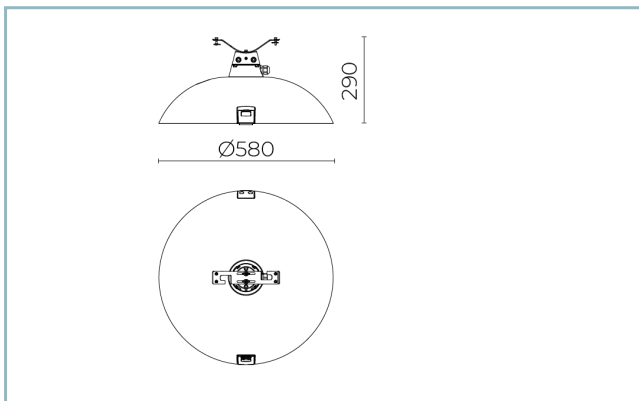

Performance Data*

Source flux:	10035 lm
Source power:	65 W
Source efficiency:	154 lm/W
Device flux:	8565 lm
Device power:	71 W
Appliance efficiency:	121 lm/W
Glare Index Category:	D6

Optical System

Source: LED R3
Color Temperature: 2200 K
Color Rendering Index (CRI): ≥ 70
Chromatic consistency (SDCM): ≤ 3
Type of optics: SO-02 Street centered
Optical group life: >100.000 h @ Ta 25°C L90B10
Photobiological safety class: EXEMPT GROUP
ULOR: 0%
DLOR: 100%
Light intensity category: G*4
BUG rating: B2-U0-G1

Normative References

EN60598-1 / EN60598-2-3 / EN61547 / EN62471, EN55015 / EN61000-3-2 / EN61000-3-3

Installation and maintenance

Installation: suspension for string $\varnothing 6 \div 12$ mm, inclination horizontal $\pm 15^\circ$, adjustability $0^\circ \div 360^\circ$
\varnothing power cable: $10 \div 14$ mm
Cable Gland: PG16
Replaceable wiring plate: removable plate
Replaceable optical unit: each LED module is replaceable
Screen opening: opening by clip, fall block
Disconnecter: automatic (with terminal section 2.5 mm^2)
Power supply compartment: independent from the optical system

Flow adjustment

On request

Virtual Midnight Teaching	X
Arrangement for Zhaga connector (Book 18)	X
Constant flow output (CLO)	X
Adjusting 1-10V	X
DALI control	X
Mains voltage variation	X
Power line telemanagement (PLC)	X
Wireless remote management	X
Provision for motion/light sensors	X

Materials

Body: die-cast aluminium alloy UNI EN AB 47100 (copper content $< 1\%$)
Screen: tempered flat glass
Lenses: high-transparency PMMA
Fixing system: die-cast aluminium alloy UNI EN AB 47100 (copper content $< 1\%$)
Seals: expanded anti-age silicone foam
Screws: stainless steel AISI 304
Wiring plate: zinc-plated steel
Finish: phospho-chromatation treated and polyester powder-coated in 16 phases to increase weather resistance

Colors

■ Sablé 100 Noir	Code: 01VO6D648126CHM4
------------------	-------------------------------

Product Sheet

Rev 24/05/2024

Volta String Suspension

Size: medium

Color Temperature: 2200 K

Type of optics: SO-02 Street centered

01VO6D648126CHM4Colour: Sablé 100 Noir

NOTES***Performance data**

The values indicated in this data sheet are nominal values with a tolerance of +/-7%.

Source flux and source efficiency data refer to the LED module without optics; in case you are interested in the performance of the LED module complete with optical system, you must multiply the data reported by the factor 0.9.

General Data

The characteristics of the product listed may be subject to change and must be confirmed when ordering.

In order to promote constant updating of its products, Cariboni Group reserves the right to make changes without prior notice.