



General Features

Description: LED luminaire

Insulation class: class II

Rated voltage: 220-240 V 50/60 Hz

Protection Grade: IP66

Impact protection: IK09

Surge protection device: integrated 10kV-10kA, Type 3, equipped with LED signaling and thermofusible for disconnection at the end of life; impulse withstand CL II 10kV DM

Power Factor: > 0.90

Ambient temperature Ta: -30°C +50°C

Weight: 8.2 kg

Max exposed surface: 0.19 m²

Lateral exposed surface: 0.07 m²

Common mode surge protection: 10 kV

Overtoltage protection differential mode: 10 kV

Driver: included

Driver lifetime: >100.000 h @ Ta 25°C (0,2% / 1000h)

Marks and Certifications: ENEC / CE

Performance Data*

Source flux:	7515 lm
Source power:	43 W
Source efficiency:	175 lm/W
Device flux:	6410 lm
Device power:	47 W
Appliance efficiency:	136 lm/W
Glare Index Category:	D5

Optical System

Source: LED R2
Color Temperature: 2700 K
Color Rendering Index (CRI): ≥ 70
Chromatic consistency (SDCM): ≤ 3
Type of optics: LT-63 Asymmetric beam
Optical group life: >100.000 h @ Ta 25°C L90B10
Photobiological safety class: EXEMPT GROUP
ULOR: 0%
DLOR: 100%
Light intensity category: G*6
BUG rating: B1-U0-G1

Normative References

EN60598-1 / EN60598-2-3 / EN61547 / EN62471, EN55015 / EN61000-3-2 / EN61000-3-3

Installation and maintenance

Installation: arm suspension
Pole diameter: \varnothing 60 - 76 - 102 mm
\varnothing power cable: $10 \div 14$ mm
Cable Gland: PG16
Replaceable wiring plate: removable plate
Replaceable optical unit: each LED module is replaceable
Screen opening: opening by clip, fall block
Disconnecter: automatic (with terminal section 2.5 mm ²)
Power supply compartment: independent from the optical system

Flow adjustment

	On request
Virtual Midnight Teaching	X
Arrangement for Zhaga connector (Book 18)	X
Constant flow output (CLO)	X
Adjusting 1-10V	X
DALI control	X
Mains voltage variation	X
Power line telemanagement (PLC)	X
Wireless remote management	X
Provision for motion/light sensors	X

Materials

Body: die-cast aluminium alloy UNI EN AB 47100 (copper content $< 1\%$)
Screen: tempered flat glass
Lenses: high-transparency PMMA
Fixing system: die-cast aluminium alloy UNI EN AB 47100 (copper content $< 1\%$)
Seals: expanded anti-age silicone foam
Screws: stainless steel AISI 304
Wiring plate: zinc-plated steel
Finish: phospho-chromatation treated and polyester powder-coated in 16 phases to increase weather resistance

Colors

■ Sablé 100 Noir	Code: 01VO2C448815CHM4
------------------	-------------------------------

Mandatory accessories



01AK907C0

L16 Male suspension kit
1" 1/2 GAS. Colour: Sablé 100 Noir.



01AK914C0

L17 Male suspension kit
3/4" GAS. Colour: Sablé 100 Noir.

Optional accessories



01AK988C0

B212 Single arm
for poles \varnothing 60-76 mm. Colour: Sablé 100 Noir.



01AK989C0

B213 Double arm
for poles \varnothing 60-76 mm. Colour: Sablé 100 Noir.

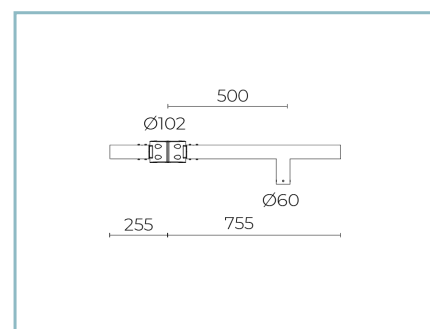

01AK990C0

B214 Single arm
for poles \varnothing 102 mm. Colour: Sablé 100 Noir.



01AK991C0

B215 Double arm
for poles \varnothing 102 mm. Colour: Sablé 100 Noir.



01AK992C0

B216 Single arm
for poles \varnothing 60-76 mm. Colour: Sablé 100 Noir.

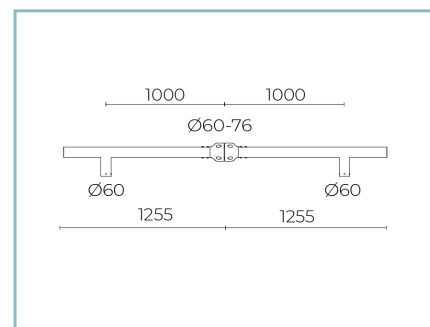

01AK994C0

B217 Double arm
for poles \varnothing 60-76 mm. Colour: Sablé 100 Noir.



01AK995C0

B218 Single arm
for poles Ø 102 mm. Colour: Sablé 100
Noir.



01AK996C0

B219 Double arm
for poles Ø 102 mm. Colour: Sablé 100
Noir.



01AK983C0

B207-P Suspension wall-mounted
arm. Colour: Sablé 100 Noir.



01AK935C0

B15 Single curved arm
Ø 60 mm for poles Ø 102 mm. L=810
mm. Colour: Sablé 100 Noir.



01AK936C0

B16 Double curved arm
Ø 60 mm for poles Ø 102 mm. L=810
mm. Colour: Sablé 100 Noir.



01AK950C0

B15-P Curved wall-mounted arm
Ø 60 mm. L=840 mm. Colour: Sablé
100 Noir.

NOTES

*Performance data

The values indicated in this data sheet are nominal values with a tolerance of +/-7%.

Source flux and source efficiency data refer to the LED module without optics; in case you are interested in the performance of the LED module complete with optical system, you must multiply the data reported by the factor 0.9.

General Data

The characteristics of the product listed may be subject to change and must be confirmed when ordering.

In order to promote constant updating of its products, Cariboni Group reserves the right to make changes without prior notice.