

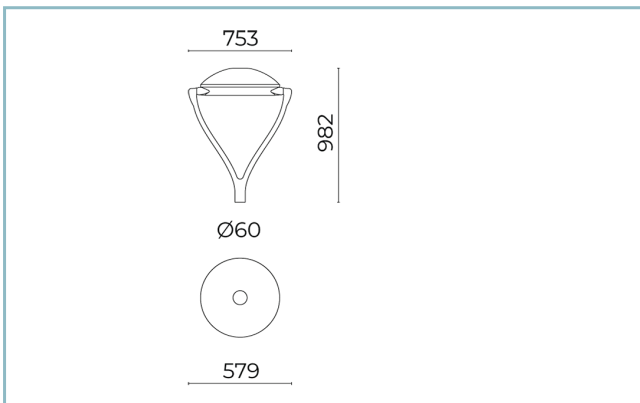

General Features

Description: urban and public lighting luminaire
Insulation class: class II
Rated voltage: 220-240 V 50/60 Hz
Protection Grade: IP66
Impact protection: IK08
Surge protection device: integrated 10kV-10kA, Type 3, equipped with LED signaling and thermofusible for disconnection at the end of life; impulse withstand CL II 10kV DM
Power Factor: > 0.9
Ambient temperature Ta: -30°C +50°C
Weight: 16.00 kg
Max exposed surface: 0,25 m ²
Lateral exposed surface: 0,14 m ²
Common mode surge protection: 10 kV
Overtoltage protection differential mode: 10 kV
Driver: included
Marks and Certifications: CE



Performance Data*

LED Current:	525 mA
Source flux:	3100 lm
Source power:	17.5 W
Source efficiency:	177 lm/W
Device flux:	2665 lm
Device power:	20 W
Appliance efficiency:	133 lm/W
Glare Index Category:	D6

Optical System

Source: LED R1
Color Temperature: 3000 K
Color Rendering Index (CRI): ≥ 70
Chromatic consistency (SDCM): ≤ 4
Type of optics: ME-01 Medium street
Optical group life: >130.000h @700mA @Ta25°C TM21 L80B20 >130.000h @700mA @Ta25°C TM21 L80B10
Photobiological safety class: EXEMPT GROUP
ULOR: 0%
DLOR: 100%
Light intensity category: G*3
BUG rating: B1-U0-G0

Normative References

EN60598-1 / EN60598-2-3 / EN62471

Installation and maintenance

Installation: post top, pole side
Pole diameter: \varnothing 60 - 76 mm
Tilt: fastened or adjustable installation
Fixing: 2 x AISI 304 stainless steel securing bolts
Wiring: Junction box IP68. The connection to the electrical backbone can be made without having to open the device
\varnothing power cable: 10 ÷ 14 mm
Cable Gland: PG16
Replaceable wiring plate: removable plate
Replaceable optical unit: each LED module is replaceable
Screen opening: glass holder frame opening, fall block
Disconnecter: automatic (with terminal section 2.5 mm ²)

Flow adjustment

	On request
Virtual Midnight Teaching	X
Constant flow output (CLO)	X
Adjusting 1-10V	X
DALI control	X
Mains voltage variation	X
Power line telemanagement (PLC)	X
Wireless remote management	X

Materials

Body: die-cast aluminium alloy UNI EN AB 47100 (copper content < 1%), upper dome with aluminium plate turning
Screen: tempered flat glass
Lenses: high-transparency PMMA
Fixing system: die-cast aluminium alloy UNI EN AB 47100 (copper content < 1%)
Seals: expanded anti-age silicone foam
Screws: stainless steel AISI 304
Wiring plate: zinc-plated steel
Finish: phospho-chromatation treated and polyester powder-coated in 16 phases to increase weather resistance

Colors

■ Sablé 100 Noir	Code: 01FY3B25932CHM4
------------------	------------------------------

Optional accessories



01AY904C0

L7 Reduction Ø 60-68 mm
for poles Ø 76 mm. Colour: Sablé 100
Noir.

NOTES

*Performance data

The values indicated in this data sheet are nominal values with a tolerance of +/-7%.

Source flux and source efficiency data refer to the LED module without optics; in case you are interested in the performance of the LED module complete with optical system, you must multiply the data reported by the factor 0.9.

General Data

The characteristics of the product listed may be subject to change and must be confirmed when ordering.

In order to promote constant updating of its products, Cariboni Group reserves the right to make changes without prior notice.